

maverick complete



Maverick Complete, our popular and complete series with the ability to mix and match two of our 20 standard colors to provide modern day durability for any office space.

Features

Maverick Complete Series is standard with full modesty panel, full pedestals to floor, locking, handles. Hutch with fascia, grommets on credenzas, bridges and returns.

Edge Profile



Side View



Product Specifications

Colors

- 20 standard colors are available on tops and chassis. Two colors may be specified at no charge.

Top / Worksurfaces

- 1" TFM (Thermally Fused Melamine) on industrial quality (45 lb.) particleboard.
- 2 mm thermally-fused PVC edge banding.
- Conference table tops present a 1¼" built-up edge.
- Metal-to-metal connection fittings are installed for bridges and returns.
- Woodgrain direction on tops of bridges and returns runs from user side to approach side to coordinate with main unit tops.

Chassis Construction

- TFM chassis fastened by screws, steel brackets, and/or concealed fasteners.
- 1"-thick end panels on desks, returns, credenzas, and bookcases. ¾" thick end panels on hutches.
- Full-height modesty panel is standard on all desks, credenzas, bridges & returns; ½" modesty may be specified at no upcharge on bridges and returns, where specified. Full pedestal to floor is standard. Full modesty is 27 ⅝"H and ½ modesty is 14"H.
- Bullet desks are standard with full modesty panel and have 4" black metal posts.
- Conference tables, see conference section for Maverick series (MM).
- Unless otherwise specified, conference and round table bases are the same color as the top. Contrasting colors may be specified at no charge.
- The modesty inset on the approach side for 30"-deep tops is 6"; for 36"-deep tops, inset is 12".
- The modesty panel is flush to the approach edge on 20"-and 24"-deep tops.
- Visible edges are edged with 2 mm thermally-fused PVC edge banding.
- Adjustable leveling glides are provided on all units that are designed to be set on the floor.
- Hutches for Maverick Complete are designed to fit Maverick Complete.
- Product heights are coordinated to facilitate matching, e.g., credenza plus hutch is 65" high. Optional 72" height is available, see page 92 for height upgrade.
- Standard woodgrain direction on the modesty of pieces 60" wide or less is vertical. On pieces wider than 60", the grain direction is horizontal.
- Lateral file and vertical file chassis are all ¾" material.

Drawer Interiors

- 9-ply Birch wood drawers.

Drawer Suspension, Construction and Doors

- Box drawers have full-extension, progressive-action slides with precision steel ball bearings.
- Heavy-duty file rods in file drawers.
- H3B handles and locks are standard. (except hutches and hinged door wall mounts)
- Overlay drawer front and doors are standard on all separate storage units and separate file units. Other furniture with storage and lateral file elements are inset to the end panels of chassis and overlay at the kneespace.
- All file and lateral drawers file legal-size from side-to-side.
- Each desk only is provided with one box drawer convenience tray. See page 95 for optional additional trays for other units.
- File drawer construction accommodates hanging files not stacked material on drawer bottom.
- Hutch doors overlay sides before inset to top with 19" clearance below.

Cord Management

- Centered grommets in the worksurface and modesty are standard on bridges, credenzas and returns; ¾" clearance at bottom of hutch backs.
- Optional grommets on page 91.

Locks

- Locks are standard on all pedestals, lateral files, freestanding pedestals and storage cabinets.
- Black or silver, removable cores are standard for all locks.
- Lock numbers (#101-115) are randomly assigned to all locking pedestals, except that double pedestal units will be keyed alike.
- Key alike may be specified at no charge.
- Master keys and keyed-alike combinations are available.

Note: Dimensions assigned in this price list are nominal. If exact measurements are required, the requirement must be specified in the order and specifically acknowledged by Maverick. Maverick reserves the right to change construction details and standards without notification, if necessary.

Line Drawings shown are a resemblance to finished product. Product designs may vary. Discounts are different between factories.

How to Order Maverick Complete

WORKSURFACE UNITS: DESK, CREDENZAS AND RETURNS

1. Product number: **MC S 36 72 L**
-
- Handle Option
 Width
 Depth
 Product Type: Single Pedestal Desk (See page 56)
 Series Name: Maverick Complete

2. Specify Worksurface color. Matching color edge is standard.
3. Specify Drawer or Door Front Color (matching color edge band is standard). For two colors add \$133 list.
4. Specify Chassis color. Matching color edge banding is standard. Modesty color same as chassis is standard.
5. Specify Handle Option. Choice of handle is standard. H3B is standard if none specified. (Handles H11, H30, & APH1 charges apply)
6. Black grommets are standard where shown on line drawings.
7. Specify Other Accessories or Upgrades. See pages 93-97.

STANDARD HANDLE OPTIONS

H3B is standard unless otherwise specified.



Crescent Black
(MMH3B)



Crescent Silver
(MMH3S)



Elliptical Black
(MMH5B)



Elliptical Silver
(MMH5S)



Crescent Textured Nickel
(MMH6)



Flared Nickel
(MMH7)



Bow Handle
(MMH8)



Curved Handle
(MMH9)



Bar Square Handle
(MMH10B)

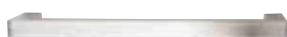

Bar Square Handle
(MMH10S)



Bar Handle
(MMH14)

IMPORTANT NOTE: Handles and locks are standard on All pedestals, lateral files, free standing pedestals and cabinets where specified.

maverick complete

FEATURES

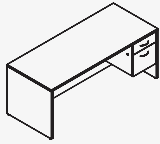

3/4 Pedestal
box/file (S)

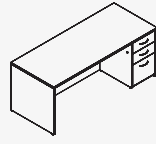

Full Pedestal
box/box/file (C)

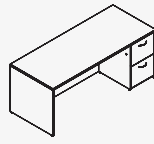

Full Pedestal
file/file (D)

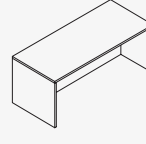

Full Modesty
(FMP)

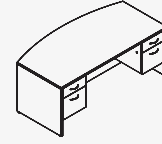

Fan Top
(F)

GROMMETS



GROMMET

Black grommets are standard where shown.
Upgrade to silver color, N/C.

NOTE: While sitting at unit, grommet locations named from left to right. For grommet location on tops and/or modesty panel specify left, center or right. **No grommets over pedestals.**

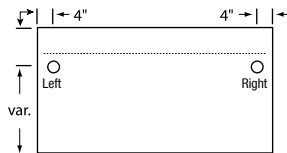

Desks

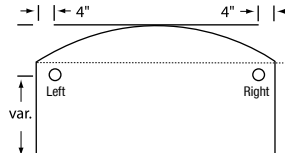

Desks

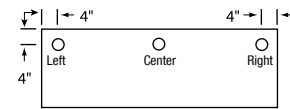

Credenza, Return,
Bridges*

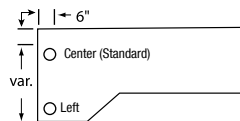

CompuCredenza*

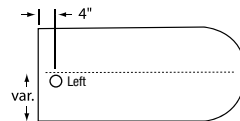

Bullets*

***NOTE: BLACK GROMMETS ARE STANDARD WHERE SHOWN ON LINE DRAWINGS**

maverick complete

Statement of Line

DESK

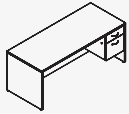

Desk - single pedestal (S)

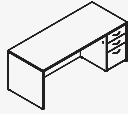

Desk - single pedestal (SC)

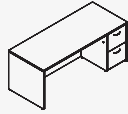

Desk - single pedestal (SD)

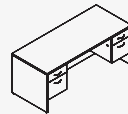

Desk - double pedestal (D)

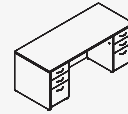

Desk - double pedestal (DC)

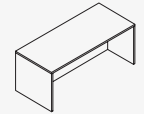

Desk - shell (N)

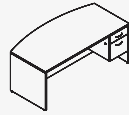

Desk Fan Top - sgl. ped. (FS)

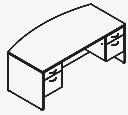

Desk Fan Top - dbl. ped. (FD)



Bullet Computer Desk (BDC)

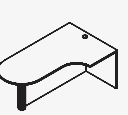

Bullet Computer Desk Curved (BDCQ)

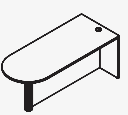

Bullet Desk - standard (BD)

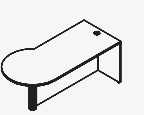

Desk - P-shape (PBD)

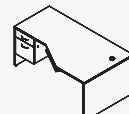

Comp. Desk - sgl. ped. (CD72 9)

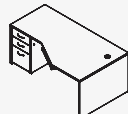

Comp. Desk - sgl. ped. (CD72C 9)

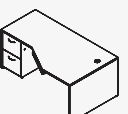

Comp. Desk - sgl. ped. (CD72D 9)

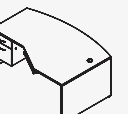

Fan Top Comp. Desk - sgl. ped. (FCD72 9)

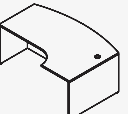

Fan Top Comp. Desk Curved - shell (FCDNQ72 9)

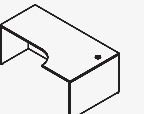

Curve Comp. Desk Shell (CDNQ72 9)

CREDENZAS

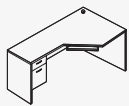

CompuCorner - sgl. ped. (CD)

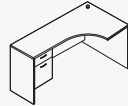

CompuCorner Curved - sgl. ped. (CDQ)

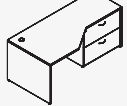

CompuCorner - 31" lateral (CDLF)

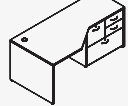

CompuCorner - 31" pers. lat. file (CDPLF)

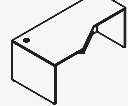

CompuCorner - shell (CDN)

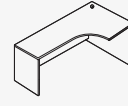

CompuCorner - curved shell (CDNQ)

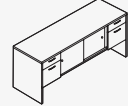

Credenza - dbl. ped. & storage (C___2)

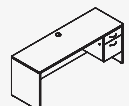

Credenza - sgl. ped. (C___4)

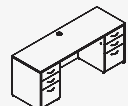

Credenza - Double Pedestal (C___3)

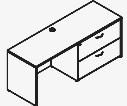

Credenza - lat. file (C___5)

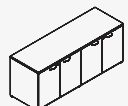

Credenza - full storage (C___1FP)

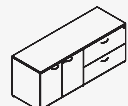

Credenza - Storage File (C___9FP)

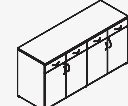

Buffet Credenza (HDBC___)

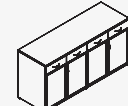

Buffet Credenza (HDBC___G)

BRIDGE

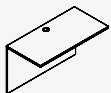

Bridge (BR)

RETURNS

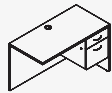

Return - 3/4 ped. (RA)



Return - BBF (RC)

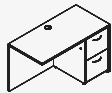

Return - FF (RD)



Return - shell (RN)

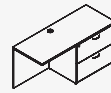

Return - lat. file (RLF)

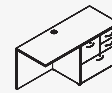

Return - Pers. Lat. File (RPLF)

maverick complete

Statement of Line

RISERS



Riser - 36"
(RB)



Riser - 48"
(RB)

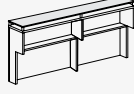

Riser - 72"
(RB)

RECEPTIONS

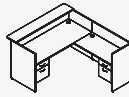

Reception - "L"
(RCAL)

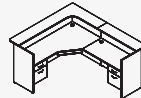

Reception - computer
(RCDL)

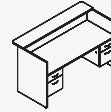

Reception - front
(RCAD)

HUTCHES

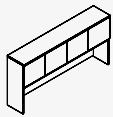

Hutch - with doors
(H_WD)

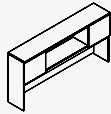

Hutch - 2 door
(H_W2D)

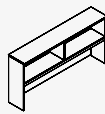

Hutch - no doors
(H_ND)

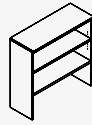

Hutch - bookcase
(BCH)

BOOKCASES



Bookcase
(BC)

FILING



Lateral File
(LF2)



Lateral File - 3-drawer
(LF3)



Lateral File - 4-drawer
(LF4)

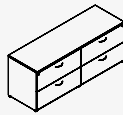

Lateral File - double
(LF_2+2)

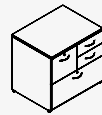

Lateral File - personal
(PLF)



Vertical File
(VF)

STORAGE

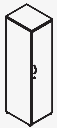

Cabinet - single
(STS)

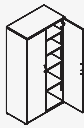

Cabinet - double
(ST)

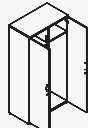

Cabinet - wardrobe
(WC)

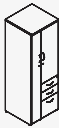

Personal Storage Unit
(WCP)



Cabinet - utility
(HDC)



Cabinet - Wall Mount
(CFOHD)

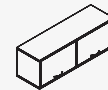

Cabinet - Wall Mount
(CFOHB)

STANDS

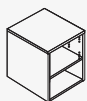

Printer Stand
(PS)

PEDESTALS



Mobile - box/box/file
(PEDCX)



Mobile - file/file
(PEDDX)



Mobile - Pencil/Box/file
(PEDEX)



Mobile - Box/file
(PEDAX)



Slim Mobile - Pencil/Box/file
(PEDSX)

maverick complete

Configurations - Are available for  and 

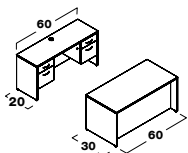

MC1	
1 MCD3060	\$1,659
1 MCC2060 3	\$1,774
	\$3,433

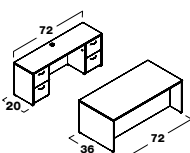

MC2	
1 MCDC3672	\$2,791
1 MCCD2072 3	\$2,696
	\$5,487

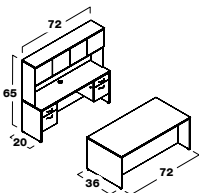

MC3	
1 MCD3672	\$2,002
1 MCC2072 3	\$2,088
1 MCH72WD	\$1,836
	\$5,926

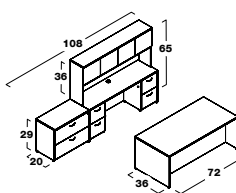

MC4	
1 MCDC3672	\$2,791
1 MCCD2072 3	\$2,696
1 MCH72WD	\$1,836
1 MCLF202	\$1,564
	\$8,887

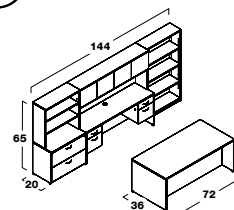

MC5	
1 MCD3672	\$2,002
1 MCC2072 3	\$2,088
1 MCH72WD	\$1,836
1 MCLF202	\$1,564
1 MCBCH	\$607
1 MCBC3665	\$1,053
	\$9,150

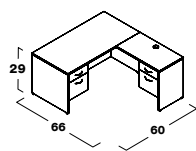

MC6R	
1 MCS3060L	\$1,336
1 MCRA2036R	\$1,267
	\$2,603

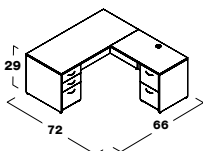

MC7R	
1 MCSC3066L	\$2,038
1 MCRD2442R	\$1,895
	\$3,933

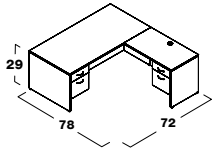

MC8R	
1 MCS3672L	\$1,568
1 MCRA2442R	\$1,441
	\$3,009

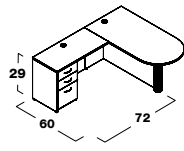

MC9L	
1 MCB3060L	\$1,251
1 MCR2042L	\$1,850
	\$3,101

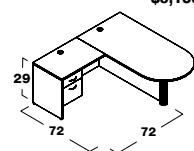

MC10L	
1 MCB3672L	\$1,491
1 MCRA2436L	\$1,402
	\$2,893

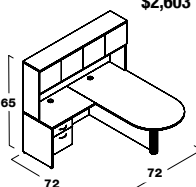

MC11L	
1 MCB3672L	\$1,491
1 MCRA2436L	\$1,402
1 MCH72WD	\$1,836
	\$4,729

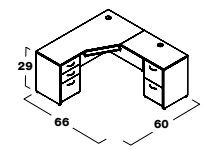

MC12R	
1 MCCD66C 4L	\$2,241
1 MCRD2436R	\$1,882
	\$4,123

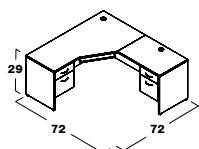

MC13R	
1 MCCD72 4L	\$1,612
1 MCRA2436R	\$1,402
	\$3,014

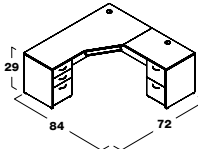

MC14R	
1 MCCD72C 4L	\$2,169
1 MCRD2448R	\$1,938
	\$4,107

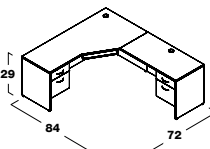

MC15R	
1 MCCD72 4L	\$1,612
1 MCRA2448R	\$1,460
	\$3,072

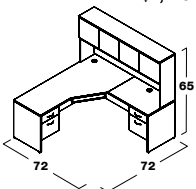

MC16R	
1 MCCD72 4L	\$1,612
1 MCRA2436R	\$1,402
1 MCH72WD	\$1,836
	\$4,850

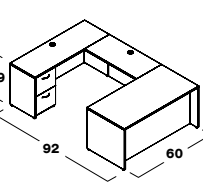

MC17L	
1 MCSC3060R	\$1,895
1 MCBR2042	\$573
1 MCCD2060 4L	\$1,886
	\$4,354

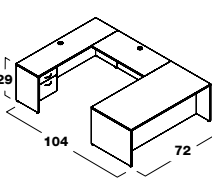

MC18L	
1 MCS3672R	\$1,568
1 MCBR2448	\$756
1 MCC2072 4L	\$1,593
	\$3,917

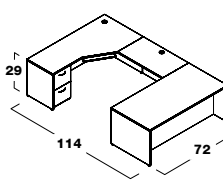

MC19L	
1 MCSC3672R	\$2,130
1 MCBR2442	\$698
1 MCCD72D 4L	\$2,087
	\$4,915

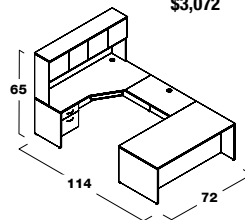

MC20L	
1 MCS3672R	\$1,568
1 MCBR2442	\$698
1 MCCD72 4L	\$1,612
1 MCH72WD	\$1,836
	\$5,714

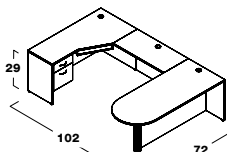

MC21L	
1 MCB3072L	\$1,412
1 MCBR2042	\$573
1 MCCD60 2L	\$1,550
	\$3,535

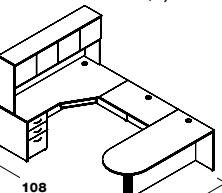

MC22L	
1 MCB3072L	\$1,412
1 MCBR2442	\$698
1 MCCD72C 4L	\$2,169
1 MCH72WD	\$1,836
	\$6,115

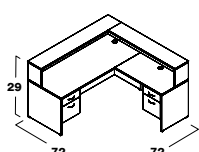

MC23R	
1 MCS3072L	\$1,500
1 MCRA2442R	\$1,441
1 MMRB72	\$976
1 MMRBR60R	\$772
	\$4,689

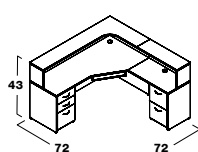

MC24R	
1 MCCD72C 7L	\$2,310
1 MCRD2036R	\$1,745
1 MMRBL3672R	\$1,427
1 MMRBR36R	\$480
	\$5,962

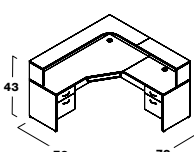

MC25R	
1 MCCD72 4L	\$1,612
1 MCRA2436R	\$1,402
1 MMRBL3672R	\$1,427
1 MMRBR36R	\$480
	\$4,921

NOTE: FOR RISERS SEE MAVERICK SERIES (MM) P. 34

Use "R" or "L" to indicate the position of the return. Configurations are a small sample of total available. Configurations can be used with limited upgrade options for .

maverick complete

Curved Configurations & Teaming Set-up - Available for  and 

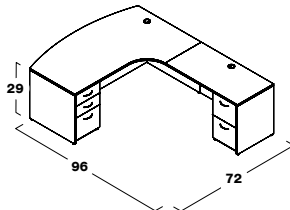

15 DAYS	MCQ26R		
1	MCFC072C 9L	\$2,867	
1	MCRD2448R	\$1,938	
		\$4,805	

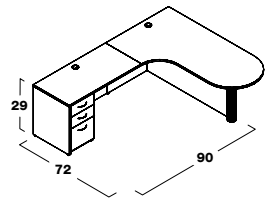

	MCQ27L		
1	MCBDCQ427230L	\$1,521	
1	MCR2448L	\$2,023	
		\$3,544	

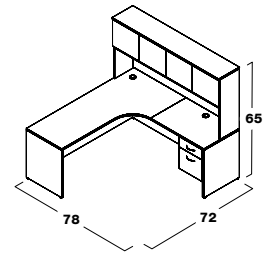

	MCQ28R		
1	MCCDNQ72 4R	\$1,371	
1	MCRA2436R	\$1,402	
1	MCH72WD	\$1,836	
		\$4,609	

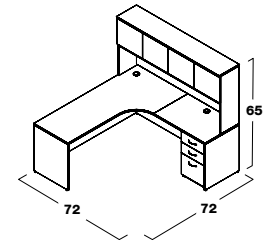

	MCQ29R		
1	MCCDNQ72 4R	\$1,371	
1	MCR2436R	\$1,963	
1	MCH72WD	\$1,836	
		\$5,170	

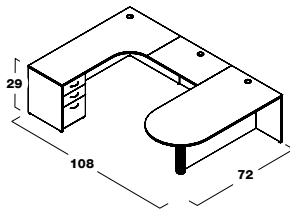

	MCQ30L		
1	MCBD3672L	\$1,491	
1	MCBR2436	\$596	
1	MCCDQ72C 4L	\$2,169	
		\$4,256	

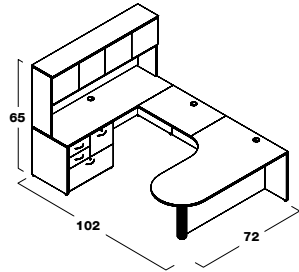

15 DAYS	MCQ31L		
1	MCBDCQ427230L	\$1,521	
1	MCBR2436	\$596	
1	MCC2472 6L	\$2,647	
1	MCH72WD	\$1,836	
		\$6,600	

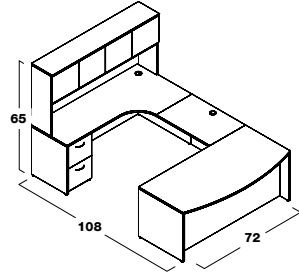

	MCQ32L		
1	MCFSC3672R	\$2,453	
1	MCBR2436	\$596	
1	MCCDQ72D 4L	\$2,087	
1	MCH72WD	\$1,836	
		\$6,972	

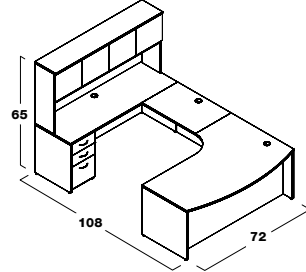

15 DAYS	MCQ33L		
1	MCFC072C 9R	\$2,867	
1	MCBR2436	\$596	
1	MCCC2472 4L	\$2,191	
1	MCH72WD	\$1,836	
		\$7,490	

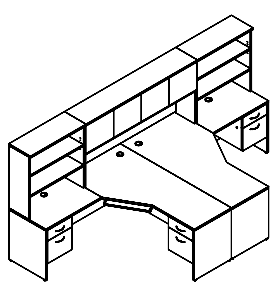

	MC34		
1	MCCD72 4R	\$1,612	
1	MCCD72 4L	\$1,912	
1	MCRA2436R	\$1,402	
1	MCRA2436L	\$1,402	
2	MCBCH	\$1,214	
1	MCH72WD	\$1,836	
		\$9,078	

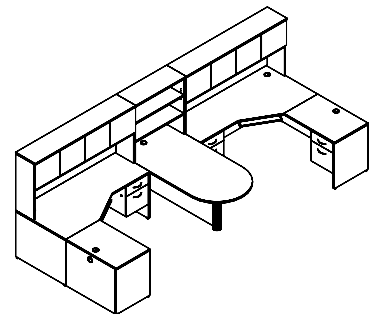

	MC35		
1	MCCD72 4R	\$1,612	
1	MCCD72 4L	\$1,612	
1	MCRA2436R	\$1,402	
1	MCRA2436L	\$1,402	
1	MCBD3672L	\$1,491	
2	MCH72WD	\$3,672	
1	MCBCH	\$607	
		\$11,798	

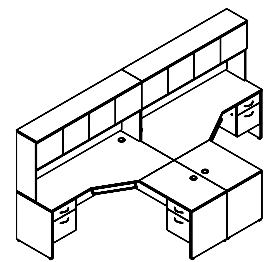

	MC36		
1	MCCD72 4R	\$1,612	
1	MCCD72 4L	\$1,612	
1	MCRA2436R	\$1,402	
1	MCRA2436L	\$1,402	
2	MCH72WD	\$3,672	
		\$9,700	

NOTE: BULLET DESK STAND ALONE w/ POST LEG, WHEN ORDERED AS MC35 CONFIGURATION, MUST SPECIFY.

Use "R" or "L" to indicate the position of the return. Configurations are a small sample of total available.

maverick complete

Desks

Single Pedestal Desk, Box/File Pedestal Right (Full modesty, H3B handles, lock)

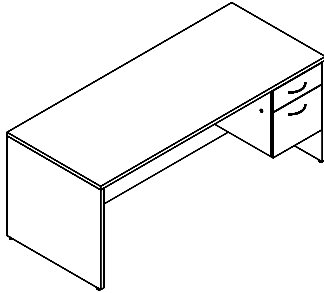

Model#	Depth	Width	Height	Weight	Cube	Price
☞ MCS2042R	20"	42"	29"	120	15	\$1,237
☞ MCS2060R	20"	60"	29"	150	20	\$1,318
☞ MCS2066R	20"	66"	29"	156	23	\$1,461
☞ MCS2072R	20"	72"	29"	163	24	\$1,477
☞ MCS2442R	24"	42"	29"	127	18	\$1,274
☞ MCS2448R	24"	48"	29"	130	20	\$1,297
☞ MCS3048R	30"	48"	29"	142	25	\$1,315
☞ MCS3060R	30"	60"	29"	190	32	\$1,336
☞ MCS3066R	30"	66"	29"	197	35	\$1,477
☞ MCS3072R	30"	72"	29"	210	38	\$1,500
☞ MCS3672R	36"	72"	29"	225	45	\$1,568

Single Pedestal Desk, Box/Box/File Pedestal Right (Full modesty, H3B handles, lock)

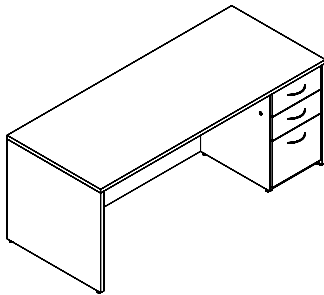

Model#	Depth	Width	Height	Weight	Cube	Price
☞ MCSC2042R	20"	42"	29"	155	15	\$1,795
☞ MCSC2060R	20"	60"	29"	180	20	\$1,873
☞ MCSC2066R	20"	66"	29"	190	23	\$2,016
☞ MCSC2072R	20"	72"	29"	200	24	\$2,038
☞ MCSC2442R	24"	42"	29"	175	18	\$1,836
☞ MCSC2448R	24"	48"	29"	183	20	\$1,858
☞ MCSC3048R	30"	48"	29"	203	25	\$1,873
☞ MCSC3060R	30"	60"	29"	224	32	\$1,895
☞ MCSC3066R	30"	66"	29"	234	35	\$2,038
☞ MCSC3072R	30"	72"	29"	244	38	\$2,057
☞ MCSC3672R	36"	72"	29"	267	45	\$2,130

Single Pedestal Desk, File/File Pedestal Right (Full modesty, H3B handles, lock)

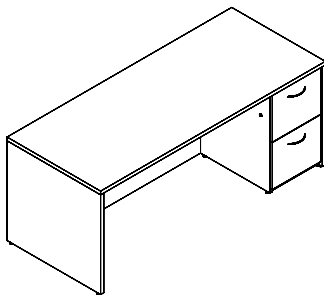

Model#	Depth	Width	Height	Weight	Cube	Price
☞ MCSD2042R	20"	42"	29"	155	15	\$1,714
☞ MCSD2060R	20"	60"	29"	180	20	\$1,793
☞ MCSD2066R	20"	66"	29"	190	23	\$1,935
☞ MCSD2072R	20"	72"	29"	200	24	\$1,953
☞ MCSD2442R	24"	42"	29"	175	18	\$1,752
☞ MCSD2448R	24"	48"	29"	183	20	\$1,776
☞ MCSD3048R	30"	48"	29"	203	25	\$1,793
☞ MCSD3060R	30"	60"	29"	224	32	\$1,813
☞ MCSD3066R	30"	66"	29"	234	35	\$1,953
☞ MCSD3072R	30"	72"	29"	244	38	\$1,977
☞ MCSD3672R	36"	72"	29"	267	45	\$2,047

maverick complete

Desks

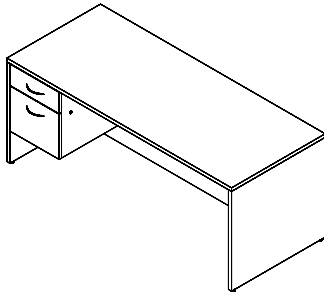

Single Pedestal Desk, Box/File Pedestal Left (Full modesty, H3B handles, lock)

Model#	Depth	Width	Height	Weight	Cube	Price
☞ MCS2042L	20"	42"	29"	120	15	\$1,237
☞ MCS2060L	20"	60"	29"	150	20	\$1,318
☞ MCS2066L	20"	66"	29"	156	23	\$1,461
☞ MCS2072L	20"	72"	29"	163	24	\$1,477
☞ MCS2442L	24"	42"	29"	127	18	\$1,274
☞ MCS2448L	24"	48"	29"	130	20	\$1,297
☞ MCS3048L	30"	48"	29"	142	25	\$1,315
☞ MCS3060L	30"	60"	29"	190	32	\$1,336
☞ MCS3066L	30"	66"	29"	197	35	\$1,477
☞ MCS3072L	30"	72"	29"	210	38	\$1,500
☞ MCS3672L	36"	72"	29"	225	45	\$1,568

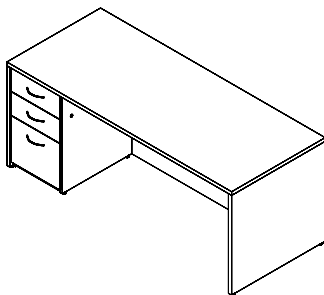

Single Pedestal Desk, Box/Box/File Pedestal Left (Full modesty, H3B handles, lock)

Model#	Depth	Width	Height	Weight	Cube	Price
☞ MCSC2042L	20"	42"	29"	120	15	\$1,795
☞ MCSC2060L	20"	60"	29"	150	20	\$1,873
☞ MCSC2066L	20"	66"	29"	156	23	\$2,016
☞ MCSC2072L	20"	72"	29"	163	24	\$2,038
☞ MCSC2442L	24"	42"	29"	127	18	\$1,836
☞ MCSC2448L	24"	48"	29"	130	20	\$1,858
☞ MCSC3048L	30"	48"	29"	142	25	\$1,873
☞ MCSC3060L	30"	60"	29"	190	32	\$1,895
☞ MCSC3066L	30"	66"	29"	197	35	\$2,038
☞ MCSC3072L	30"	72"	29"	210	38	\$2,057
☞ MCSC3672L	36"	72"	29"	225	45	\$2,130

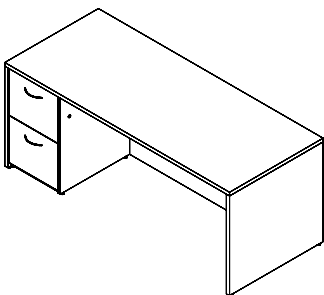

Single Pedestal Desk, File/File Pedestal Left (Full modesty, H3B handles, lock)

Model#	Depth	Width	Height	Weight	Cube	Price
☞ MCSD2042L	20"	42"	29"	120	15	\$1,714
☞ MCSD2060L	20"	60"	29"	150	20	\$1,793
☞ MCSD2066L	20"	66"	29"	156	23	\$1,935
☞ MCSD2072L	20"	72"	29"	163	24	\$1,953
☞ MCSD2442L	24"	42"	29"	127	18	\$1,752
☞ MCSD2448L	24"	48"	29"	130	20	\$1,776
☞ MCSD3048L	30"	48"	29"	142	25	\$1,793
☞ MCSD3060L	30"	60"	29"	190	32	\$1,813
☞ MCSD3066L	30"	66"	29"	197	35	\$1,953
☞ MCSD3072L	30"	72"	29"	210	38	\$1,977
☞ MCSD3672L	36"	72"	29"	225	45	\$2,047

See available accessories and upgrades, pp. 93-97.

maverick complete

Desks

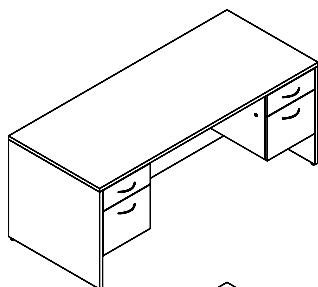

Double Pedestal Desk, Box/File Pedestals Left and Right
(Full modesty, H3B Handles, 2 Locks)

Model#	Depth	Width	Height	Weight	Cube	Price
☞ MCD3060	30"	60"	29"	260	32	\$1,659
☞ MCD3066	30"	66"	29"	266	35	\$1,955
☞ MCD3072	30"	72"	29"	270	38	\$1,983
☞ MCD3672	36"	72"	29"	276	45	\$2,002

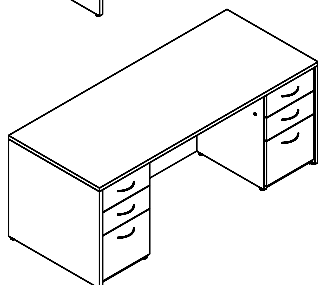

Double Pedestal Desk, Box/Box/File Pedestals Left and Right
(Full Modesty, H3B Handles, 2 Locks)

Model#	Depth	Width	Height	Weight	Cube	Price
☞ MCDC3060	30"	60"	29"	294	32	\$2,381
☞ MCDC3066	30"	66"	29"	304	35	\$2,741
☞ MCDC3072	30"	72"	29"	314	38	\$2,772
☞ MCDC3672	36"	72"	29"	337	45	\$2,791

For left Box/Box/File and right File/File configuration use MCDCD ____ N/C.

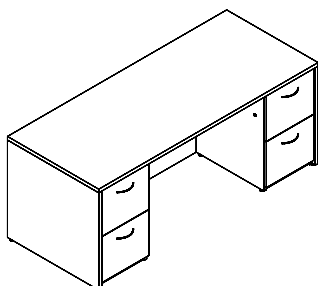

Double Pedestal Desk, File/File Pedestals Left and Right
(Full Modesty, H3B Handles, 2 Locks)

Model#	Depth	Width	Height	Weight	Cube	Price
☞ MCDD3060	30"	60"	29"	294	32	\$2,272
☞ MCDD3066	30"	66"	29"	304	35	\$2,631
☞ MCDD3072	30"	72"	29"	314	38	\$2,660
☞ MCDD3672	36"	72"	29"	337	45	\$2,682

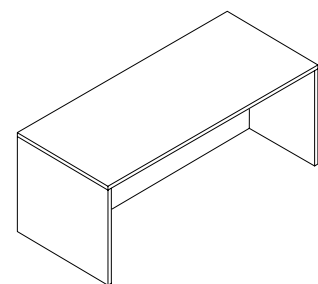

Desk Shell No-Pedestal, Full Modesty (Flush Modesty)

Model#	Depth	Width	Height	Weight	Cube	Price
☞ MCN2042	20"	42"	29"	84	17	\$712
☞ MCN2048	20"	48"	29"	84	17	\$730
☞ MCN2060	20"	60"	29"	92	20	\$783
☞ MCN2066	20"	66"	29"	96	23	\$832
☞ MCN2072	20"	72"	29"	100	24	\$852
☞ MCN2436	24"	36"	29"	89	16	\$720
☞ MCN2442	24"	42"	29"	95	18	\$783
☞ MCN2448	24"	48"	29"	104	20	\$801
☞ MCN2460	24"	60"	29"	120	25	\$852
☞ MCN2466	24"	66"	29"	127	28	\$954
☞ MCN2472	24"	72"	29"	132	30	\$1,015

For left or right 1/2 leg specify on order...N/C. Modesty is flush.

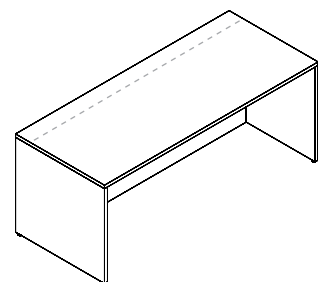

Desk Shell No-Pedestal, Full Modesty (30"D-6" Inset Modesty, 36"D-12" Inset Modesty)

Model#	Depth	Width	Height	Weight	Cube	Price
☞ MCN3042	30"	42"	29"	114	22	\$852
☞ MCN3048	30"	48"	29"	120	25	\$875
☞ MCN3060	30"	60"	29"	126	32	\$894
☞ MCN3066	30"	66"	29"	132	35	\$987
☞ MCN3072	30"	72"	29"	138	38	\$1,015
☞ MCN3672	36"	72"	29"	152	45	\$1,035

For left or right 1/2 leg specify on order...N/C. Modesty is Inset 6" on 30"D & 12" on 36"D.

See available accessories and upgrades, pp. 93-97.

maverick complete

Desks

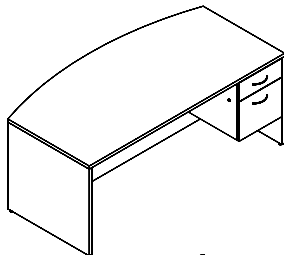

Fan Top Single Pedestal Desk, Box/File Right (Full Modesty, H3B Handles, Lock)

Model#	Depth	Width	Height	Weight	Cube	Price
☞ MCF S3672R	30-36"	72"	29"	233	45	\$1,892
☞ MCF S4272R	36-42"	72"	29"	258	53	\$1,952

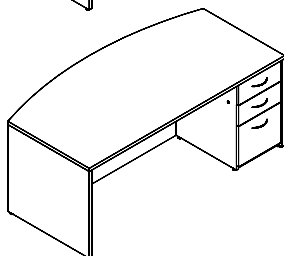

Fan Top Single Pedestal Desk, Box/Box/File Right (Full Modesty, H3B Handles, Lock)

Model#	Depth	Width	Height	Weight	Cube	Price
☞ MCF SC3672R	30-36"	72"	29"	265	45	\$2,453
☞ MCF SC4272R	36-42"	72"	29"	280	53	\$2,511

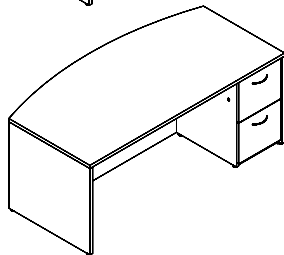

Fan Top Single Pedestal Desk, File/File Right (Full Modesty, H3B Handles, Lock)

Model#	Depth	Width	Height	Weight	Cube	Price
☞ MCF SD3672R	30-36"	72"	29"	265	45	\$2,371
☞ MCF SD4272R	36-42"	72"	29"	280	53	\$2,427

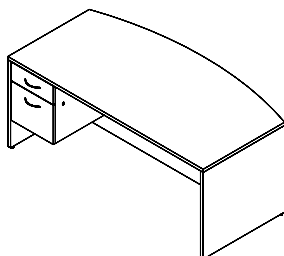

Fan Top Single Pedestal Desk, Box/File Left (Full Modesty, H3B Handles, Lock)

Model#	Depth	Width	Height	Weight	Cube	Price
☞ MCF S3672L	30-36"	72"	29"	233	45	\$1,892
☞ MCF S4272L	36-42"	72"	29"	258	53	\$1,952

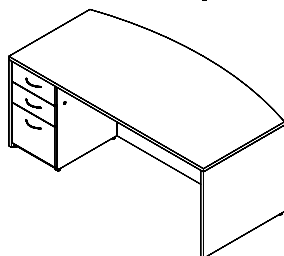

Fan Top Single Pedestal Desk, Box/Box/File Left (Full Modesty, H3B Handles, Lock)

Model#	Depth	Width	Height	Weight	Cube	Price
☞ MCF SC3672L	30-36"	72"	29"	265	45	\$2,453
☞ MCF SC4272L	36-42"	72"	29"	280	53	\$2,511

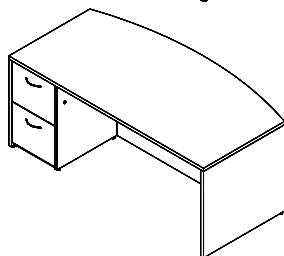

Fan Top Single Pedestal Desk, File/File Left (Full Modesty, H3B Handles, Lock)

Model#	Depth	Width	Height	Weight	Cube	Price
☞ MCF SD3672L	30-36"	72"	29"	265	45	\$2,371
☞ MCF SD4272L	36-42"	72"	29"	280	53	\$2,427

See available accessories and upgrades, pp. 93-97.

maverick complete

Desks

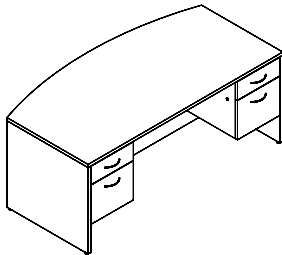

Fan Top Double Pedestal, Box/File Left and Right
(Full Modesty, H3B Handles, 2 Locks)

Model#	Depth	Width	Height	Weight	Cube	Price
☞ MCFD3672	30-36"	72"	29"	280	45	\$2,360
☞ MCFD4272	36-42"	72"	29"	305	53	\$2,377

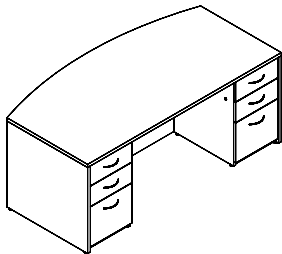

Fan Top Double Pedestal Desk, Box/Box/File Left and Right
(Full Modesty, H3B Handles, 2 Locks)

Model#	Depth	Width	Height	Weight	Cube	Price
☞ MCFDC3672	30-36"	72"	29"	335	45	\$3,078
☞ MCFDC4272	36-42"	72"	29"	350	53	\$3,095

For left Box/Box/File and right File/File configuration use MCFDCD____. N/C.

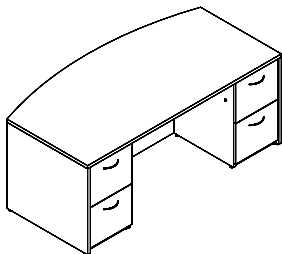

Fan Top Double Pedestal Desk, File/File Left and Right
(Full Modesty, H3B Handles, 2 Locks)

Model#	Depth	Width	Height	Weight	Cube	Price
☞ MCFDD3672	30-36"	72"	29"	335	45	\$2,968
☞ MCFDD4272	36-42"	72"	29"	350	53	\$2,984

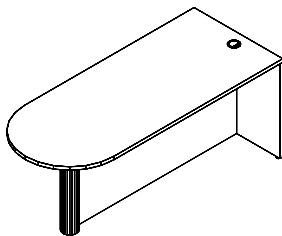

Bullet Desk, (Full modesty, 4" black post, centered black grommet) For Right Return

Model#	Depth	Width	Height	Weight	Cube	Price
☞ MCBD3060R	30"	60"	29"	180	32	\$1,251
☞ MCBD3072R	30"	72"	29"	195	35	\$1,412
☞ MCBD3660R	36"	60"	29"	185	38	\$1,412
☞ MCBD3672R	36"	72"	29"	205	45	\$1,491

For silver post upgrade, add MMUHLEGJS...\$40. Upgrade grommet cover to silver, N/C.
Note: Specify if standalone. Standalone Bullet Desk is made with 1/2 leg (MMSPT) at no charge, replaces post leg.

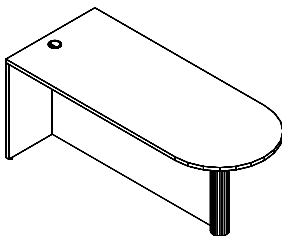

Bullet Desk, (Full modesty, 4" black post, centered black grommet) For Left Return

Model#	Depth	Width	Height	Weight	Cube	Price
☞ MCBD3060L	30"	60"	29"	180	32	\$1,251
☞ MCBD3072L	30"	72"	29"	195	35	\$1,412
☞ MCBD3660L	36"	60"	29"	185	38	\$1,412
☞ MCBD3672L	36"	72"	29"	205	45	\$1,491

For silver post upgrade, add MMUHLEGJS...\$40. Upgrade grommet cover to silver, N/C.
Note: Specify if standalone. Standalone Bullet Desk is made with 1/2 leg (MMSPT) at no charge, replaces post leg.

maverick complete

Desks

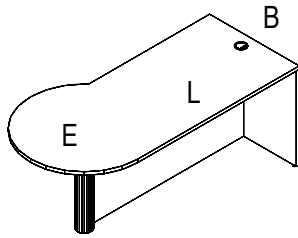

P-shape Desk (Full modesty, 4" black post) For Right Return

Model#	Depth (B,E)	Width (L)	Height	Weight	Cube	Price
MCPBD3072R	30/36"	72"	29"	200	45	\$1,685
MCPBD3672R	36/42"	72"	29"	205	53	\$1,765
MCPBD3678R	36/42"	78"	29"	215	49	\$1,908
MCPBD3684R	36/42"	84"	29"	225	62	\$2,181

Black grommet standard. Upgrade grommet cover to silver, N/C. For silver post upgrade, add MMUHLEGJS...\$40.

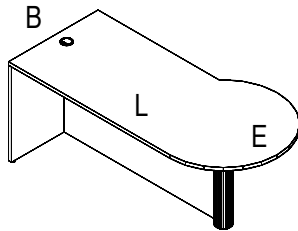

P-shape Desk (Full modesty, 4" black post) For Left Return

Model#	Depth (B,E)	Width (L)	Height	Weight	Cube	Price
MCPBD3072L	30/36"	72"	29"	200	45	\$1,685
MCPBD3672L	36/42"	72"	29"	205	53	\$1,765
MCPBD3678L	36/42"	78"	29"	215	49	\$1,908
MCPBD3684L	36/42"	84"	29"	225	62	\$2,181

Black grommet standard. Upgrade grommet cover to silver, N/C. For silver post upgrade, add MMUHLEGJS...\$40.

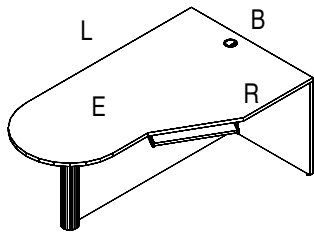

Bullet Computer Desk (Full modesty, 4" black post) For Right Return

Model#	Depth (B,E)	Width (L,R)	Height	Weight	Cube	Price
☞ MCBDC427230R	42/30"	72"/24"	29"	195	53	\$1,521
☞ MCBDC427830R	42/30"	78"/24"	29"	205	58	\$1,841

Keyboard tray and worksurface black grommet are standard. Upgrade grommet cover to silver, N/C. For silver post upgrade, add MMUHLEGJS...\$40.

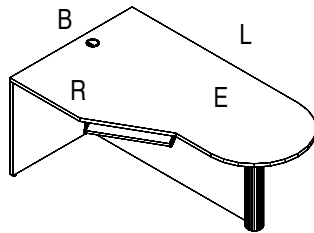

Bullet Computer Desk (Full modesty, 4" black post) For Left Return

Model#	Depth (B,E)	Width (L,R)	Height	Weight	Cube	Price
☞ MCBDC427230L	42/30"	72"/24"	29"	195	53	\$1,521
☞ MCBDC427830L	42/30"	78"/24"	29"	205	58	\$1,841

Keyboard tray and worksurface black grommet are standard. Upgrade grommet cover to silver, N/C. For silver post upgrade, add MMUHLEGJS...\$40.

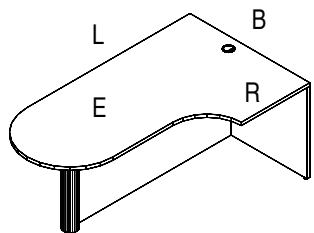

Bullet Computer Desk, Curved (Full modesty, 4" black post) For Right Return

Model#	Depth (B,E)	Width (L,R)	Height	Weight	Cube	Price
☞ MCBDCQ427230R	42/30"	72"/24"	29"	195	53	\$1,521

Worksurface black grommet standard. Upgrade grommet cover to silver, N/C. For silver post upgrade, add MMUHLEGJS...\$40.

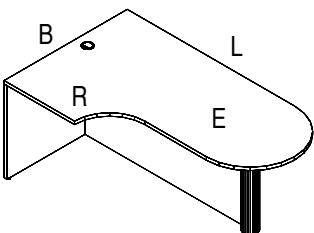

Bullet Computer Desk, Curved (Full modesty, 4" black post) For Left Return

Model#	Depth (B,E)	Width (L,R)	Height	Weight	Cube	Price
☞ MCBDCQ427230L	42/30"	72"/24"	29"	195	53	\$1,521

Worksurface black grommet standard. Upgrade grommet cover to silver, N/C. For silver post upgrade, add MMUHLEGJS...\$40.

NOTE: For all P-shape bullet & bullet computer desks, specify if standalone. Standalone is made with 1/2 leg (MMSPT) at no charge, replaces post leg.

See available accessories and upgrades, pp. 93-97.

maverick complete

Desks

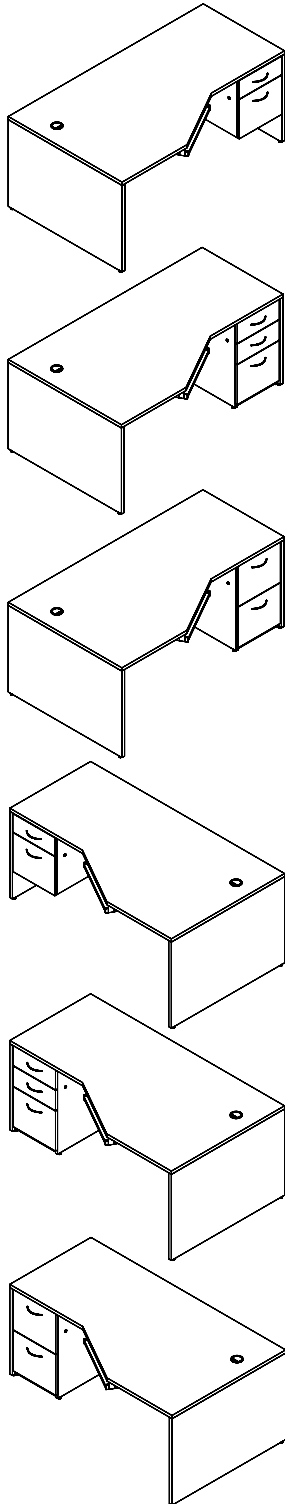

Computer Desk, Box/File Pedestal Right (Full modesty inset 6", H3B Handles, Lock)

Model	(L)	(B)	(E)	(K)	(R)	(W)	Weight	Cube	Price
MCCD72 9R	72"	42"	30"	24"	24"	27"	285	45	\$2,157

Keyboard tray and worksurface black grommet are standard. Upgrade grommet cover to silver, N/C.

Computer Desk, Box/Box/File Pedestal Right (Full modesty inset 6", H3B Handles, Lock)

Model	(L)	(B)	(E)	(K)	(R)	(W)	Weight	Cube	Price
MCCD72C 9R	72"	42"	30"	24"	24"	27"	300	45	\$2,714

Keyboard tray and worksurface black grommet are standard. Upgrade grommet cover to silver, N/C.

Computer Desk, File/File Pedestal Right (Full modesty inset 6", H3B Handles, Lock)

Model	(L)	(B)	(E)	(K)	(R)	(W)	Weight	Cube	Price
MCCD72D 9R	72"	42"	30"	24"	24"	27"	300	45	\$2,633

Keyboard tray and worksurface black grommet are standard. Upgrade grommet cover to silver, N/C.

Computer Desk, Box/File Pedestal Left (Full modesty inset 6", H3B Handles, Lock)

Model	(L)	(B)	(E)	(K)	(R)	(W)	Weight	Cube	Price
MCCD72 9L	72"	42"	30"	24"	24"	27"	285	45	\$2,157

Keyboard tray and worksurface black grommet are standard. Upgrade grommet cover to silver, N/C.

Computer Desk, Box/Box/File Pedestal Left (Full modesty inset 6", H3B Handles, Lock)

Model	(L)	(B)	(E)	(K)	(R)	(W)	Weight	Cube	Price
MCCD72C 9L	72"	42"	30"	24"	24"	27"	300	45	\$2,714

Keyboard tray and worksurface black grommet are standard. Upgrade grommet cover to silver, N/C.

Computer Desk, File/File Pedestal Left (Full modesty inset 6", H3B Handles, Lock)

Model	(L)	(B)	(E)	(K)	(R)	(W)	Weight	Cube	Price
MCCD72D 9L	72"	42"	30"	24"	24"	27"	300	45	\$2,633

Keyboard tray and worksurface black grommet are standard. Upgrade grommet cover to silver, N/C.

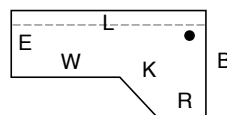

- "L" Length along approach edge
- "B" Back end panel
- "E" End panel
- "K" Keyboard space
- "R" Return size to attach
- "W" Workarea (kbrd to end)

See available accessories and upgrades, pp. 93-97.

maverick complete

Desks

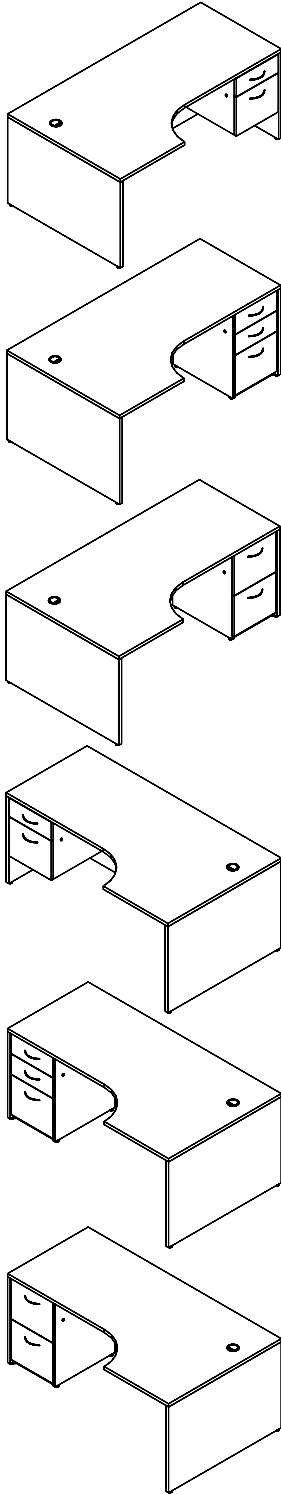

Computer Desk, Curved, Box/File Pedestal Right (Full modesty inset 6", H3B Handles, Lock)

Model	(L)	(B)	(E)	(K)	(R)	(W)	Weight	Cube	Price
MCCDQ72 9R	72"	42"	30"	24"	24"	27"	285	45	\$2,157

No keyboard tray. Worksurface black grommet standard. Upgrade grommet cover to silver, N/C.

Computer Desk, Curved, Box/Box/File Pedestal Right (Full modesty inset 6", H3B Handles, Lock)

Model	(L)	(B)	(E)	(K)	(R)	(W)	Weight	Cube	Price
MCCDQ72C 9R	72"	42"	30"	24"	24"	27"	300	45	\$2,714

No keyboard tray. Worksurface black grommet standard. Upgrade grommet cover to silver, N/C.

Computer Desk, Curved, File/File Pedestal Right (Full modesty inset 6", H3B Handles, Lock)

Model	(L)	(B)	(E)	(K)	(R)	(W)	Weight	Cube	Price
MCCDQ72D 9R	72"	42"	30"	24"	24"	27"	300	45	\$2,633

No keyboard tray. Worksurface black grommet standard. Upgrade grommet cover to silver, N/C.

Computer Desk, Curved, Box/File Pedestal Left (Full modesty inset 6", H3B Handles, Lock)

Model	(L)	(B)	(E)	(K)	(R)	(W)	Weight	Cube	Price
MCCDQ72 9L	72"	42"	30"	24"	24"	27"	285	45	\$2,157

No keyboard tray. Worksurface black grommet standard. Upgrade grommet cover to silver, N/C.

Computer Desk, Curved, Box/Box/File Pedestal Left (Full modesty inset 6", H3B Handles, Lock)

Model	(L)	(B)	(E)	(K)	(R)	(W)	Weight	Cube	Price
MCCDQ72C 9L	72"	42"	30"	24"	24"	27"	300	45	\$2,714

No keyboard tray. Worksurface black grommet standard. Upgrade grommet cover to silver, N/C.

Computer Desk, Curved, File/File Pedestal Left (Full modesty inset 6", H3B Handles, Lock)

Model	(L)	(B)	(E)	(K)	(R)	(W)	Weight	Cube	Price
MCCDQ72D 9L	72"	42"	30"	24"	24"	27"	300	45	\$2,633

No keyboard tray. Worksurface black grommet standard. Upgrade grommet cover to silver, N/C.

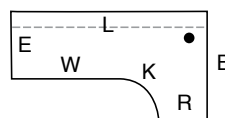

- "L" Length along approach edge
- "B" Back end panel
- "E" End panel
- "K" Keyboard space
- "R" Return size to attach
- "W" Workarea (kbrd to end)

See available accessories and upgrades, pp. 93-97.

maverick complete

Desks

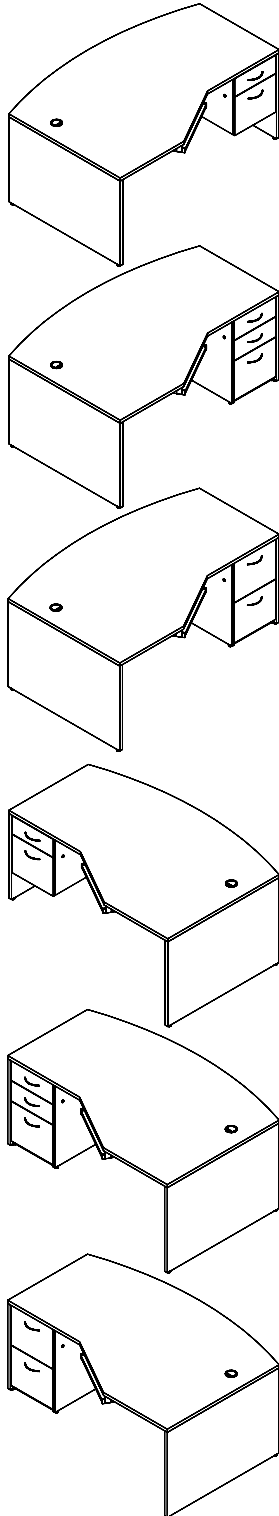

Fan Top Computer Desk, Box/File Pedestal Right (Full modesty inset 6", H3B Handles, Lock)

Model	(L)	(B)	(E)	(K)	(R)	(W)	Weight	Cube	Price
MCFCD72 9R	72"	42"+	30"	24"	24"	27"	295	48	\$2,306

Keyboard tray and worksurface black grommet are standard. Fan front adds 6" to overall depth. Upgrade grommet cover to silver, N/C.

Fan Top Computer Desk, Box/Box/File Pedestal Right (Full modesty inset 6", H3B Handles, Lock)

Model	(L)	(B)	(E)	(K)	(R)	(W)	Weight	Cube	Price
MCFCD72C 9R	72"	42"+	30"	24"	24"	27"	310	48	\$2,867

Keyboard tray and worksurface black grommet are standard. Fan front adds 6" to overall depth. Upgrade grommet cover to silver, N/C.

Fan Top Computer Desk, File/File Pedestal Right (Full modesty inset 6", H3B Handles, Lock)

Model	(L)	(B)	(E)	(K)	(R)	(W)	Weight	Cube	Price
MCFCD72D 9R	72"	42"+	30"	24"	24"	27"	310	48	\$2,783

Keyboard tray and worksurface black grommet are standard. Fan front adds 6" to overall depth. Upgrade grommet cover to silver, N/C.

Fan Top Computer Desk, Box/File Pedestal Left (Full modesty inset 6", H3B Handles, Lock)

Model	(L)	(B)	(E)	(K)	(R)	(W)	Weight	Cube	Price
MCFCD72 9L	72"	42"+	30"	24"	24"	27"	295	48	\$2,306

Keyboard tray and worksurface black grommet are standard. Upgrade grommet cover to silver, N/C. Fan front adds 6" to overall depth.

Fan Top Computer Desk, Box/Box/File Pedestal Left (Full modesty inset 6", H3B Handles, Lock)

Model	(L)	(B)	(E)	(K)	(R)	(W)	Weight	Cube	Price
MCFCD72C 9L	72"	42"+	30"	24"	24"	27"	310	48	\$2,867

Keyboard tray and worksurface black grommet are standard. Upgrade grommet cover to silver, N/C. Fan front adds 6" to overall depth.

Fan Top Computer Desk, File/File Pedestal Left (Full modesty inset 6", H3B Handles, Lock)

Model	(L)	(B)	(E)	(K)	(R)	(W)	Weight	Cube	Price
MCFCD72D 9L	72"	42"+	30"	24"	24"	27"	310	48	\$2,783

Keyboard tray and worksurface black grommet are standard. Upgrade grommet cover to silver, N/C. Fan front adds 6" to overall depth.

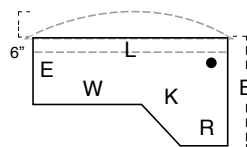

- "L" Length along approach edge
- "B" Back end panel (Fan top adds 6")
- "E" End panel
- "K" Keyboard space
- "R" Return size to attach
- "W" Workarea (kbrd to end)

See available accessories and upgrades, pp. 93-97.

maverick complete

Desks

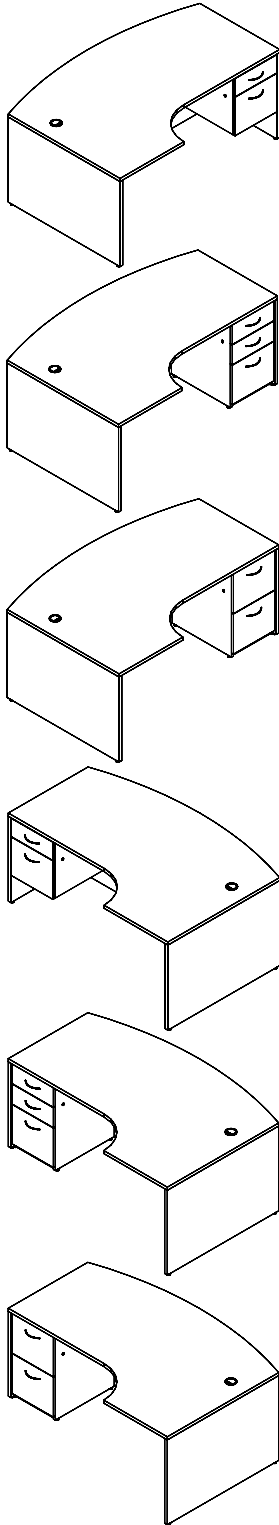

Fan Top Computer Desk, Curved, Box/File Pedestal Right (Full modesty inset 6", H3B Handles, Lock)

Model	(L)	(B)	(E)	(K)	(R)	(W)	Weight	Cube	Price
MCFCDQ72 9R	72"	42"+	30"	24"	24"	27"	295	48	\$2,306

No keyboard tray. Worksurface black grommet standard. Fan front adds 6" to overall depth.
Upgrade grommet cover to silver, N/C.

Fan Top Computer Desk, Curved, Box/Box/File Pedestal Right (Full modesty inset 6", H3B Handles, Lock)

Model	(L)	(B)	(E)	(K)	(R)	(W)	Weight	Cube	Price
MCFCDQ72C 9R	72"	42"+	30"	24"	24"	27"	310	48	\$2,867

No keyboard tray, worksurface black grommet standard. Fan front adds 6" to overall depth.
Upgrade grommet cover to silver, N/C.

Fan Top Computer Desk, Curved, File/File Pedestal Right (Full modesty inset 6", H3B Handles, Lock)

Model	(L)	(B)	(E)	(K)	(R)	(W)	Weight	Cube	Price
MCFCDQ72D 9R	72"	42"+	30"	24"	24"	27"	310	48	\$2,783

No keyboard tray, worksurface black grommet standard. Fan front adds 6" to overall depth.
Upgrade grommet cover to silver, N/C.

Fan Top Computer Desk, Curved, Box/File Pedestal Left (Full modesty inset 6", H3B Handles, Lock)

Model	(L)	(B)	(E)	(K)	(R)	(W)	Weight	Cube	Price
MCFCDQ72 9L	72"	42"+	30"	24"	24"	27"	295	48	\$2,306

No keyboard tray, worksurface black grommet standard. Fan front adds 6" to overall depth.
Upgrade grommet cover to silver, N/C.

Fan Top Computer Desk, Curved, Box/Box/File Pedestal Left (Full modesty inset 6", H3B Handles, Lock)

Model	(L)	(B)	(E)	(K)	(R)	(W)	Weight	Cube	Price
MCFCDQ72C 9L	72"	42"+	30"	24"	24"	27"	310	48	\$2,867

No keyboard tray, worksurface black grommet standard. Fan front adds 6" to overall depth.
Upgrade grommet cover to silver, N/C.

Fan Top Computer Desk, Curved, File/File Pedestal Left (Full modesty inset 6", H3B Handles, Lock)

Model	(L)	(B)	(E)	(K)	(R)	(W)	Weight	Cube	Price
MCFCDQ72D 9L	72"	42"+	30"	24"	24"	27"	310	48	\$2,783

No keyboard tray worksurface black grommet standard. Fan front adds 6" to overall depth.
Upgrade grommet cover to silver, N/C.

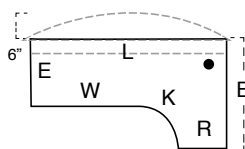

- "L" Length along approach edge
- "B" Back end panel (Fan top adds 6")
- "E" End panel
- "K" Keyboard space
- "R" Return size to attach
- "W" Workarea (kbrd to end)

See available accessories and upgrades, pp. 93-97.

maverick complete

Desks

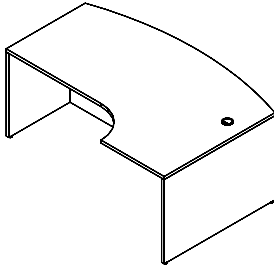

Fan Top Computer Desk Shell, Curved (Full modesty inset 6") For Right Return

Model	(L)	(B)	(E)	(K)	(R)	(W)	Weight	Cube	Price
MCFCDNQ72 9R	72"	42"+	30"	24"	24"	27"	215	48	\$1,740

No keyboard tray. Worksurface black grommet standard. Upgrade grommet cover to silver, N/C. Fan front adds 6" to overall depth.

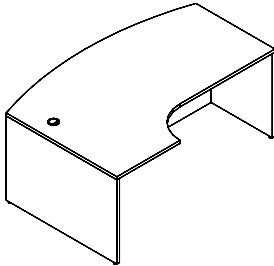

Fan Top Computer Desk Shell, Curved (Full modesty inset 6") For Left Return

Model	(L)	(B)	(E)	(K)	(R)	(W)	Weight	Cube	Price
MCFCDNQ72 9L	72"	42"+	30"	24"	24"	27"	215	48	\$1,740

No keyboard tray. Worksurface black grommet standard. Upgrade grommet cover to silver, N/C. Fan front adds 6" to overall depth.

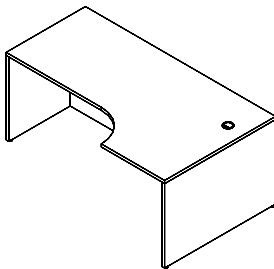

Computer Desk Shell, Curved (Full modesty inset 6") For Right Return

Model#	(L)	(B)	(E)	(K)	(R)	(W)	Weight	Cube	Price
MCCDNQ72 9R	72"	42"	30"	24"	24"	27"	215	51	\$1,740

No keyboard tray. Worksurface black grommet standard. Upgrade grommet cover to silver, N/C.

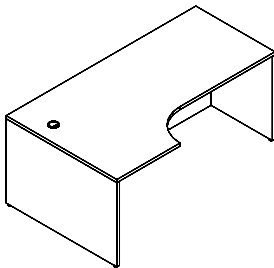

Computer Desk Shell, Curved (Full modesty inset 6") For Left Return

Model#	(L)	(B)	(E)	(K)	(R)	(W)	Weight	Cube	Price
MCCDNQ72 9L	72"	42"	30"	24"	24"	27"	215	51	\$1,740

No keyboard tray. Worksurface black grommet standard. Upgrade grommet cover to silver, N/C.

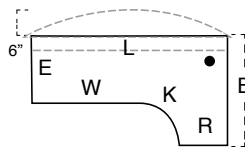

- "L" Length along approach edge
- "B" Back end panel (Fan top adds 6")
- "E" End panel
- "K" Keyboard space
- "R" Return size to attach
- "W" Workarea (kbrd to end)

maverick complete

Bridges

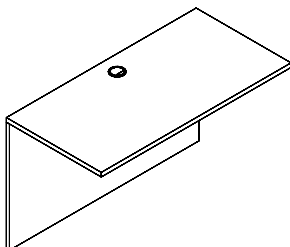

Bridge (Full modesty)

Model#	Depth	Width	Height	Weight	Cube	Price
☞ MCBR2036	20"	36"	29"	41	9	\$552
☞ MCBR2042	20"	42"	29"	48	10	\$573
☞ MCBR2048	20"	48"	29"	55	12	\$636
☞ MCBR2436	24"	36"	29"	47	10	\$596
☞ MCBR2442	24"	42"	29"	55	12	\$698
☞ MCBR2448	24"	48"	29"	63	14	\$756
☞ MCBR2460	24"	60"	29"	78	15	\$870

Full modesty standard. ½ modesty on bridges may be specified at no upcharge.
 Black grommet center top and modesty. Upgrade grommet cover to silver, N/C.
 60"W bridge requires ½ leg center support, add MMSPT \$151. (Grommet is offset to clear half leg)

Returns

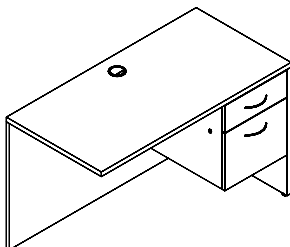

Return, ¼ Box/File Pedestal Right (Full modesty, H3B Handles, Lock)

Model#	Depth	Width	Height	Weight	Cube	Price
☞ MCRA2036R	20"	36"	29"	95	13	\$1,267
☞ MCRA2042R	20"	42"	29"	104	15	\$1,285
☞ MCRA2048R	20"	48"	29"	110	17	\$1,308
☞ MCRA2054R	20"	54"	29"	117	19	\$1,347
☞ MCRA2436R	24"	36"	29"	100	15	\$1,402
☞ MCRA2442R	24"	42"	29"	107	18	\$1,441
☞ MCRA2448R	24"	48"	29"	114	20	\$1,460
☞ MCRA2454R	24"	54"	29"	121	23	\$1,542
☞ MCRA2460R	24"	60"	29"	124	24	\$1,563
☞ MCRA3048R	30"	48"	29"	127	25	\$1,563

Full modesty standard. ½ modesty on returns may be specified at no upcharge.
 Black grommet center top and modesty. Upgrade grommet cover to silver, N/C.

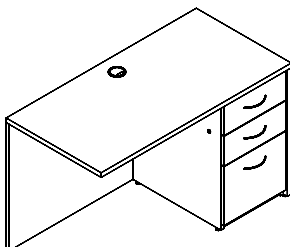

Return, Box/Box/File Pedestal Right (Full modesty, H3B Handles, Lock)

Model#	Depth	Width	Height	Weight	Cube	Price
☞ MCRC2036R	20"	36"	29"	130	13	\$1,831
☞ MCRC2042R	20"	42"	29"	140	15	\$1,850
☞ MCRC2048R	20"	48"	29"	150	17	\$1,873
☞ MCRC2054R	20"	54"	29"	160	19	\$1,914
☞ MCRC2436R	24"	36"	29"	140	15	\$1,963
☞ MCRC2442R	24"	42"	29"	150	18	\$2,006
☞ MCRC2448R	24"	48"	29"	160	20	\$2,023
☞ MCRC2454R	24"	54"	29"	170	23	\$2,108
☞ MCRC2460R	24"	60"	29"	180	24	\$2,124
☞ MCRC3048R	30"	48"	29"	175	25	\$2,124

Full modesty standard. ½ modesty on returns may be specified at no upcharge.
 Black grommet center top and modesty. Upgrade grommet cover to silver, N/C.

NOTE: If placing hutch on return, ½ leg support is required, add MMSPT \$151.

See available accessories and upgrades, pp. 93-97.

maverick complete

Returns

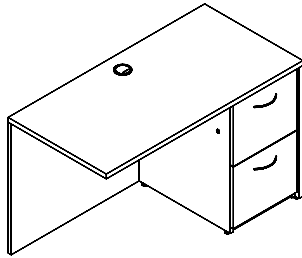

Return, File/File Pedestal Right (Full modesty, H3B Handles, Lock)

Model#	Depth	Width	Height	Weight	Cube	Price
☞ MCRD2036R	20"	36"	29"	130	13	\$1,745
☞ MCRD2042R	20"	42"	29"	140	15	\$1,765
☞ MCRD2048R	20"	48"	29"	150	17	\$1,787
☞ MCRD2054R	20"	54"	29"	160	19	\$1,828
☞ MCRD2436R	24"	36"	29"	140	15	\$1,882
☞ MCRD2442R	24"	42"	29"	150	18	\$1,895
☞ MCRD2448R	24"	48"	29"	160	20	\$1,938
☞ MCRD2454R	24"	54"	29"	170	23	\$2,024
☞ MCRD2460R	24"	60"	29"	180	24	\$2,038
☞ MCRD3048R	30"	48"	29"	175	25	\$2,038

Full modesty standard. ½ modesty on returns may be specified at no upcharge. Black grommet center top and modesty. Upgrade grommet cover to silver, N/C.

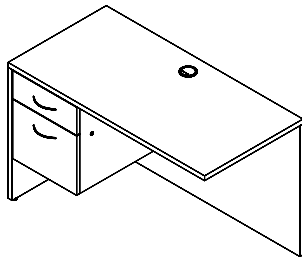

Return, ¾ Box/File Pedestal Left (Full modesty, H3B Handles, Lock)

Model#	Depth	Width	Height	Weight	Cube	Price
☞ MCRA2036L	20"	36"	29"	95	13	\$1,267
☞ MCRA2042L	20"	42"	29"	104	15	\$1,285
☞ MCRA2048L	20"	48"	29"	110	17	\$1,308
☞ MCRA2054L	20"	54"	29"	117	19	\$1,347
☞ MCRA2436L	24"	36"	29"	100	15	\$1,402
☞ MCRA2442L	24"	42"	29"	107	18	\$1,441
☞ MCRA2448L	24"	48"	29"	114	20	\$1,460
☞ MCRA2454L	24"	54"	29"	121	23	\$1,542
☞ MCRA2460L	24"	60"	29"	124	24	\$1,563
☞ MCRA3048L	30"	48"	29"	127	25	\$1,563

Full modesty standard. ½ modesty on returns may be specified at no upcharge. Black grommet center top and modesty. Upgrade grommet cover to silver, N/C.

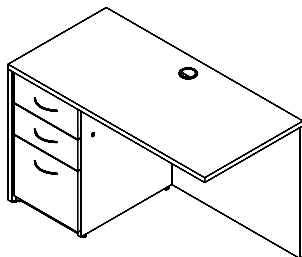

Return, Box/Box/File Pedestal Left (Full modesty, H3B Handles, Lock)

Model#	Depth	Width	Height	Weight	Cube	Price
☞ MCRC2036L	20"	36"	29"	130	13	\$1,831
☞ MCRC2042L	20"	42"	29"	140	15	\$1,850
☞ MCRC2048L	20"	48"	29"	150	17	\$1,873
☞ MCRC2054L	20"	54"	29"	160	19	\$1,914
☞ MCRC2436L	24"	36"	29"	140	15	\$1,963
☞ MCRC2442L	24"	42"	29"	150	18	\$2,006
☞ MCRC2448L	24"	48"	29"	160	20	\$2,023
☞ MCRC2454L	24"	54"	29"	170	23	\$2,108
☞ MCRC2460L	24"	60"	29"	180	24	\$2,124
☞ MCRC3048L	30"	48"	29"	175	25	\$2,124

Full modesty standard. ½ modesty on returns may be specified at no upcharge. Black grommet center top and modesty. Upgrade grommet cover to silver, N/C.

NOTE: If placing hutch on return, ½ leg support is required, add MMSPT \$151.

See available accessories and upgrades, pp. 93-97.

maverick complete

Returns

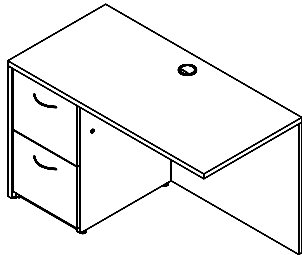

Return, File/File Pedestal Left (Full modesty, H3B Handles, Lock)

Model#	Depth	Width	Height	Weight	Cube	Price
☞ MCRD2036L	20"	36"	29"	130	13	\$1,745
☞ MCRD2042L	20"	42"	29"	140	15	\$1,765
☞ MCRD2048L	20"	48"	29"	150	17	\$1,787
☞ MCRD2054L	20"	54"	29"	160	19	\$1,828
☞ MCRD2436L	24"	36"	29"	140	15	\$1,882
☞ MCRD2442L	24"	42"	29"	150	18	\$1,895
☞ MCRD2448L	24"	48"	29"	160	20	\$1,938
☞ MCRD2454L	24"	54"	29"	170	23	\$2,024
☞ MCRD2460L	24"	60"	29"	180	24	\$2,038
☞ MCRD3048L	30"	48"	29"	175	25	\$2,038

Full modesty standard. ½ modesty on returns may be specified at no upcharge.
Black grommet center top and modesty. Upgrade grommet cover to silver, N/C.

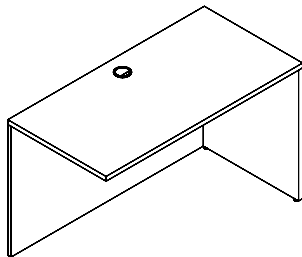

Return Shell Right (Full modesty)

Model#	Depth	Width	Height	Weight	Cube	Price
☞ MCRN2036R	20"	36"	29"	60	13	\$698
☞ MCRN2042R	20"	42"	29"	67	15	\$717
☞ MCRN2048R	20"	48"	29"	73	17	\$786
☞ MCRN2054R	20"	54"	29"	80	19	\$850
☞ MCRN2436R	24"	36"	29"	63	15	\$861
☞ MCRN2442R	24"	42"	29"	67	18	\$900
☞ MCRN2448R	24"	48"	29"	74	20	\$944
☞ MCRN2454R	24"	54"	29"	80	23	\$990
☞ MCRN3048R	30"	48"	29"	89	25	\$1,050

Full modesty standard. ½ modesty on returns may be specified at no upcharge.
Black grommet center top and modesty. Upgrade grommet cover to silver, N/C.

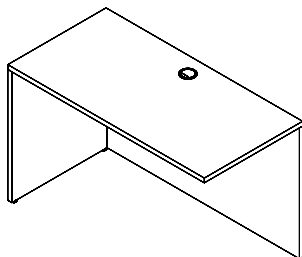

Return Shell Left (Full modesty)

Model#	Depth	Width	Height	Weight	Cube	Price
☞ MCRN2036L	20"	36"	29"	60	13	\$698
☞ MCRN2042L	20"	42"	29"	67	15	\$717
☞ MCRN2048L	20"	48"	29"	73	17	\$786
☞ MCRN2054L	20"	54"	29"	80	19	\$850
☞ MCRN2436L	24"	36"	29"	63	15	\$861
☞ MCRN2442L	24"	42"	29"	67	18	\$900
☞ MCRN2448L	24"	48"	29"	74	20	\$944
☞ MCRN2454L	24"	54"	29"	80	23	\$990
☞ MCRN3048L	30"	48"	29"	89	25	\$1,050

Full modesty standard. ½ modesty on returns may be specified at no upcharge.
Black grommet center top and modesty. Upgrade grommet cover to silver, N/C.

NOTE: If placing hutch on return, ½ leg support is required, add MMSPT \$151.

See available accessories and upgrades, pp. 93-97.

maverick complete

Returns

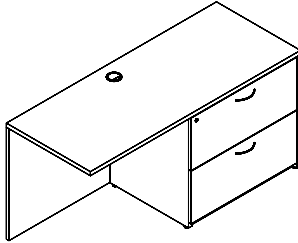

Return, Right 31" Lateral File (H3B handles, lock, full modesty)

Model#	Depth	Width	Height	Weight	Cube	Price
MCRLF2054R	20"	54"	29"	192	19	\$2,039
MCRLF2060R	20"	60"	29"	198	21	\$2,054
MCRLF2454R	24"	54"	29"	201	23	\$2,134
MCRLF2460R	24"	60"	29"	208	25	\$2,188

Black grommet center top and modesty. Upgrade grommet cover to silver, N/C.

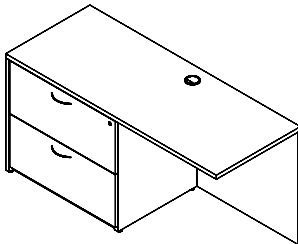

Return, Left 31" Lateral File (H3B handles, lock, full modesty)

Model#	Depth	Width	Height	Weight	Cube	Price
MCRLF2054L	20"	54"	29"	192	19	\$2,039
MCRLF2060L	20"	60"	29"	198	21	\$2,054
MCRLF2454L	24"	54"	29"	201	23	\$2,134
MCRLF2460L	24"	60"	29"	208	25	\$2,188

Black grommet center top and modesty. Upgrade grommet cover to silver, N/C.

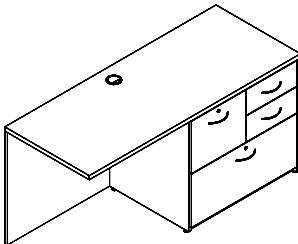

Return, Right 31" Personal Lateral File (H3B handles, locks, full modesty)

Model#	Depth	Width	Height	Weight	Cube	Price
MCRPLF2054R	20"	54"	29"	195	19	\$2,202
MCRPLF2060R	20"	60"	29"	201	23	\$2,273
MCRPLF2454R	24"	54"	29"	205	23	\$2,226
MCRPLF2460R	24"	60"	29"	213	28	\$2,317

Box drawers do not lock.

Black grommet center top and modesty. Upgrade grommet cover to silver, N/C.

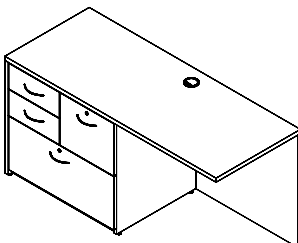

Return, Left 31" Personal Lateral File (H3B handles, locks, full modesty)

Model#	Depth	Width	Height	Weight	Cube	Price
MCRPLF2054L	20"	54"	29"	195	19	\$2,202
MCRPLF2060L	20"	60"	29"	201	23	\$2,273
MCRPLF2454L	24"	54"	29"	205	23	\$2,226
MCRPLF2460L	24"	60"	29"	213	28	\$2,317

Box drawers do not lock.

Black grommet center top and modesty. Upgrade grommet cover to silver, N/C.

NOTES:

- Returns with personal lateral file, when ordering with APH1 handles (1) lock is standard.
- If placing hutch on return, ½ leg support is required, add MMSPT \$151.

maverick complete

Credenzas

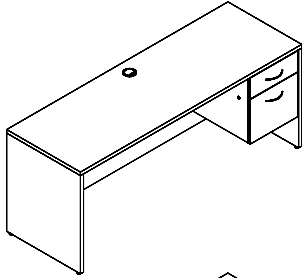

Credenza, Single Box/File Pedestal Right (Full modesty, H3B handles, lock)

Model#	Depth	Width	Height	Weight	Cube	Price
☞ MCC2060 4R	20"	60"	29"	150	21	\$1,430
☞ MCC2066 4R	20"	66"	29"	157	23	\$1,569
☞ MCC2072 4R	20"	72"	29"	164	25	\$1,593
☞ MCC2472 4R	24"	72"	29"	168	30	\$1,632

Black grommet center top and modesty. Upgrade grommet cover to silver, N/C.

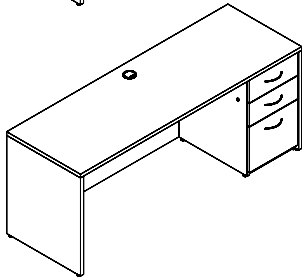

Credenza, Single Box/Box/File Pedestal Right (Full modesty, H3B handles, lock)

Model#	Depth	Width	Height	Weight	Cube	Price
☞ MCCC2060 4R	20"	60"	29"	185	21	\$1,972
☞ MCCC2066 4R	20"	66"	29"	190	23	\$2,128
☞ MCCC2072 4R	20"	72"	29"	200	25	\$2,148
☞ MCCC2472 4R	24"	72"	29"	220	30	\$2,191

Black grommet center top and modesty. Upgrade grommet cover to silver, N/C.

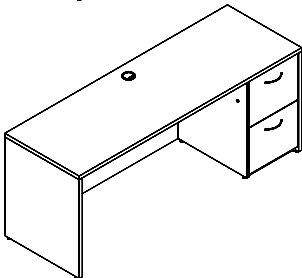

Credenza, Single File/File Pedestal Right (Full modesty, H3B handles, lock)

Model#	Depth	Width	Height	Weight	Cube	Price
☞ MCCD2060 4R	20"	60"	29"	183	21	\$1,886
☞ MCCD2066 4R	20"	66"	29"	190	23	\$2,047
☞ MCCD2072 4R	20"	72"	29"	200	25	\$2,067
☞ MCCD2472 4R	24"	72"	29"	220	30	\$2,109

Black grommet center top and modesty. Upgrade grommet cover to silver, N/C.

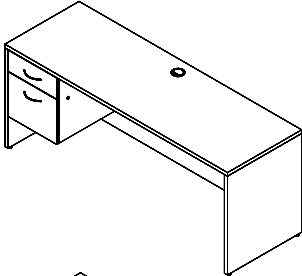

Credenza, Single Box/File Pedestal Left (Full modesty, H3B handles, lock)

Model#	Depth	Width	Height	Weight	Cube	Price
☞ MCC2060 4L	20"	60"	29"	150	21	\$1,430
☞ MCC2066 4L	20"	66"	29"	157	23	\$1,569
☞ MCC2072 4L	20"	72"	29"	164	25	\$1,593
☞ MCC2472 4L	24"	72"	29"	168	30	\$1,632

Black grommet center top and modesty. Upgrade grommet cover to silver, N/C.

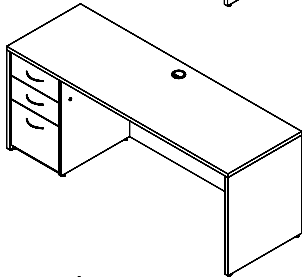

Credenza, Single Box/Box/File Pedestal Left (Full modesty, H3B handles, lock)

Model#	Depth	Width	Height	Weight	Cube	Price
☞ MCCC2060 4L	20"	60"	29"	185	21	\$1,972
☞ MCCC2066 4L	20"	66"	29"	190	23	\$2,128
☞ MCCC2072 4L	20"	72"	29"	200	25	\$2,148
☞ MCCC2472 4L	24"	72"	29"	220	30	\$2,191

Black grommet center top and modesty. Upgrade grommet cover to silver, N/C.

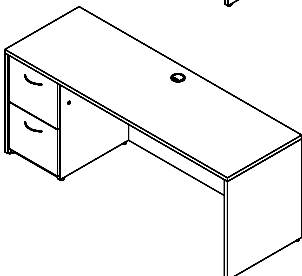

Credenza, Single File/File Pedestal Left (Full modesty, H3B handles, lock)

Model#	Depth	Width	Height	Weight	Cube	Price
☞ MCCD2060 4L	20"	60"	29"	183	21	\$1,886
☞ MCCD2066 4L	20"	66"	29"	190	23	\$2,047
☞ MCCD2072 4L	20"	72"	29"	200	25	\$2,067
☞ MCCD2472 4L	24"	72"	29"	220	30	\$2,109

Black grommet center top and modesty. Upgrade grommet cover to silver, N/C.

See available accessories and upgrades, pp. 93-97.

maverick complete

Credenzas

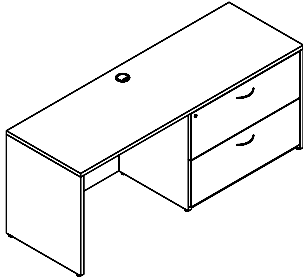

Credenza, Right 36" Lateral File Pedestal (H3B handles, lock, full modesty)

Model#	Depth	Width	Height	Weight	Cube	Price
MCC2066 5R	20"	66"	29"	223	23	\$2,198
MCC2072 5R	20"	72"	29"	230	25	\$2,218
MCC2472 5R	24"	72"	29"	270	30	\$2,318

Black grommet center top and modesty. Upgrade grommet cover to silver, N/C.

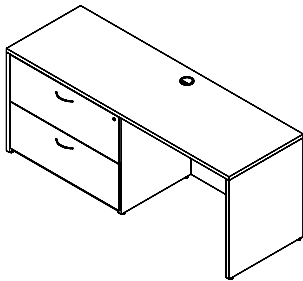

Credenza, Left 36" Lateral File Pedestal (H3B handles, lock, full modesty)

Model#	Depth	Width	Height	Weight	Cube	Price
MCC2066 5L	20"	66"	29"	223	23	\$2,198
MCC2072 5L	20"	72"	29"	230	25	\$2,218
MCC2472 5L	24"	72"	29"	270	30	\$2,318

Black grommet center top and modesty. Upgrade grommet cover to silver, N/C.

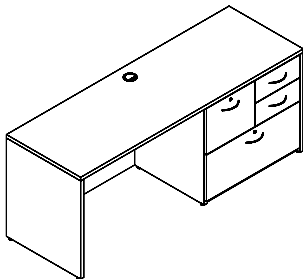

Credenza, Right 31" Personal Lateral File Pedestal (H3B handles, 2 locks, full modesty)

Model#	Depth	Width	Height	Weight	Cube	Price
MCC2066 6R	20"	66"	29"	230	26	\$2,517
MCC2072 6R	20"	72"	29"	236	28	\$2,548
MCC2472 6R	24"	72"	29"	260	30	\$2,647

Box drawers do not lock.
Black grommet center top and modesty. Upgrade grommet cover to silver, N/C.

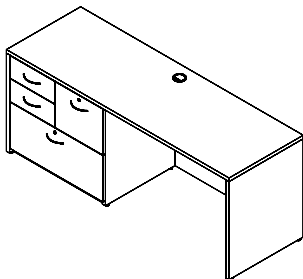

Credenza, Left 31" Personal Lateral File Pedestal (H3B handles, 2 locks, full modesty)

Model#	Depth	Width	Height	Weight	Cube	Price
MCC2066 6L	20"	66"	29"	230	26	\$2,517
MCC2072 6L	20"	72"	29"	236	28	\$2,548
MCC2472 6L	24"	72"	29"	260	30	\$2,647

Box drawers do not lock.
Black grommet center top and modesty. Upgrade grommet cover to silver, N/C.

NOTE: Returns with personal lateral file, when ordering with APH1 handles (1) lock is standard.

maverick complete

CompuCorner Credenzas

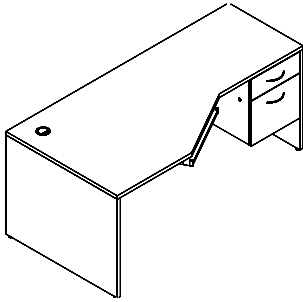

Computer Corner, Box/File Pedestal Right (H3B handles, lock, Full modesty)

Model#	(L)	(B)	(E)	(K)	(R)	(W)	Weight	Cube	Price
☞ MCCD60 2R	60"	30"	20"	21"	20"	21"	220	32	\$1,550
☞ MCCD60 4R	60"	36"	24"	21"	24"	22"	220	32	\$1,569
☞ MCCD66 4R	66"	36"	24"	21"	24"	24"	229	42	\$1,679
☞ MCCD72 3R	72"	36"	20"	24"	20"	33"	249	45	\$1,774
☞ MCCD72 4R	72"	36"	24"	21"	24"	30"	249	45	\$1,612
☞ MCCD72 7R	72"	36"	24"	23"	20"	32"	285	45	\$1,751
☞ MCCD72 8R	72"	42"	24"	24"	24"	33"	285	53	\$2,104

Keyboard tray and worksurface black grommet standard. Upgrade grommet cover to silver, N/C.

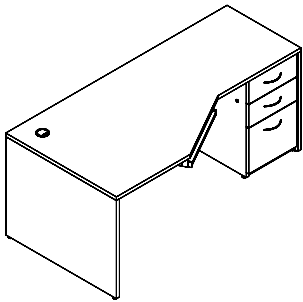

Computer Corner, Box/Box/File Pedestal Right (H3B handles, lock, Full modesty)

Model#	(L)	(B)	(E)	(K)	(R)	(W)	Weight	Cube	Price
☞ MCCD60C 2R	60"	30"	20"	21"	20"	21"	235	32	\$2,109
☞ MCCD60C 4R	60"	36"	24"	21"	24"	22"	235	32	\$2,132
☞ MCCD66C 4R	66"	36"	24"	21"	24"	24"	245	42	\$2,241
☞ MCCD72C 3R	72"	36"	20"	24"	20"	33"	265	45	\$2,331
☞ MCCD72C 4R	72"	36"	24"	21"	24"	30"	265	45	\$2,169
☞ MCCD72C 7R	72"	36"	24"	23"	20"	32"	300	45	\$2,310
☞ MCCD72C 8R	72"	42"	24"	24"	24"	33"	300	53	\$2,665

Keyboard tray and worksurface black grommet standard. Upgrade grommet cover to silver, N/C.

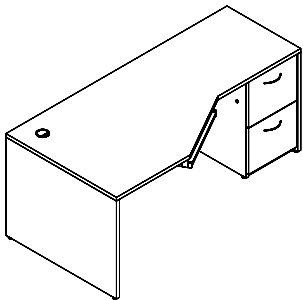

Computer Corner, File/File Pedestal Right (H3B handles, lock, Full modesty)

Model#	(L)	(B)	(E)	(K)	(R)	(W)	Weight	Cube	Price
☞ MCCD60D 2R	60"	30"	20"	21"	20"	21"	235	32	\$2,023
☞ MCCD60D 4R	60"	36"	24"	21"	24"	22"	235	32	\$2,048
☞ MCCD66D 4R	66"	36"	24"	21"	24"	24"	245	42	\$2,083
☞ MCCD72D 3R	72"	36"	20"	24"	20"	33"	265	45	\$2,176
☞ MCCD72D 4R	72"	36"	24"	21"	24"	30"	265	45	\$2,087
☞ MCCD72D 7R	72"	36"	24"	23"	20"	32"	300	45	\$2,225
☞ MCCD72D 8R	72"	42"	24"	24"	24"	33"	300	53	\$2,580

Keyboard tray and worksurface black grommet standard. Upgrade grommet cover to silver, N/C.

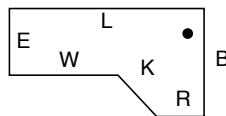

"L" Length along approach edge

"B" Back end panel

"E" End panel

"K" Keyboard space

"R" Return size to attach

"W" Workarea (kbrd to end)

maverick complete

CompuCorner Credenzas

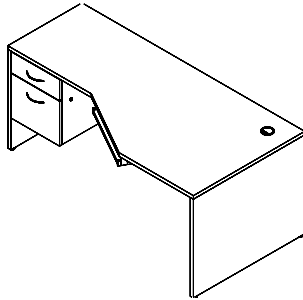

Computer Corner, Box/File Pedestal Left (H3B handles, lock, Full modesty)

Model#	(L)	(B)	(E)	(K)	(R)	(W)	Weight	Cube	Price
MCCD60 2L	60"	30"	20"	21"	20"	21"	220	32	\$1,550
MCCD60 4L	60"	36"	24"	21"	24"	22"	220	32	\$1,569
MCCD66 4L	66"	36"	24"	21"	24"	24"	229	42	\$1,679
MCCD72 3L	72"	36"	20"	24"	20"	33"	249	45	\$1,774
MCCD72 4L	72"	36"	24"	21"	24"	30"	249	45	\$1,612
MCCD72 7L	72"	36"	24"	23"	20"	32"	285	45	\$1,751
MCCD72 8L	72"	42"	24"	24"	24"	33"	285	53	\$2,104

Keyboard tray and worksurface black grommet standard. Upgrade grommet cover to silver, N/C.

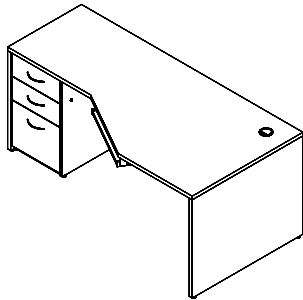

Computer Corner, Box/Box/File Pedestal Left (H3B handles, lock, Full modesty)

Model#	(L)	(B)	(E)	(K)	(R)	(W)	Weight	Cube	Price
MCCD60C 2L	60"	30"	20"	21"	20"	21"	235	32	\$2,109
MCCD60C 4L	60"	36"	24"	21"	24"	22"	235	32	\$2,132
MCCD66C 4L	66"	36"	24"	21"	24"	24"	245	42	\$2,241
MCCD72C 3L	72"	36"	20"	24"	20"	33"	265	45	\$2,331
MCCD72C 4L	72"	36"	24"	21"	24"	30"	265	45	\$2,169
MCCD72C 7L	72"	36"	24"	23"	20"	32"	300	45	\$2,310
MCCD72C 8L	72"	42"	24"	24"	24"	33"	300	53	\$2,665

Keyboard tray and worksurface black grommet standard. Upgrade grommet cover to silver, N/C.

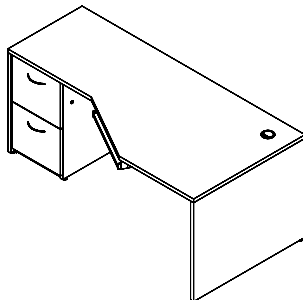

Computer Corner, File/File Pedestal Left (H3B handles, lock, Full modesty)

Model#	(L)	(B)	(E)	(K)	(R)	(W)	Weight	Cube	Price
MCCD60D 2L	60"	30"	20"	21"	20"	21"	235	32	\$2,023
MCCD60D 4L	60"	36"	24"	21"	24"	22"	235	32	\$2,048
MCCD66D 4L	66"	36"	24"	21"	24"	24"	245	42	\$2,083
MCCD72D 3L	72"	36"	20"	24"	20"	33"	265	45	\$2,176
MCCD72D 4L	72"	36"	24"	21"	24"	30"	265	45	\$2,087
MCCD72D 7L	72"	36"	24"	23"	20"	32"	300	45	\$2,225
MCCD72D 8L	72"	42"	24"	24"	24"	33"	300	53	\$2,580

Keyboard tray and worksurface black grommet standard. Upgrade grommet cover to silver, N/C.

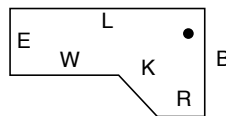

- "L" Length along approach edge
- "B" Back end panel
- "E" End panel
- "K" Keyboard space
- "R" Return size to attach
- "W" Workarea (kbrd to end)

CompuCorner Credenzas

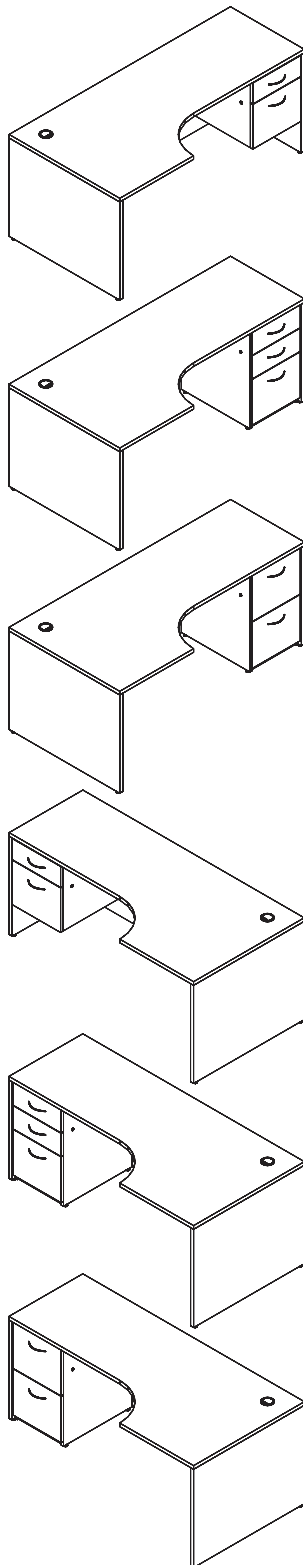

Computer Corner, Curved, 3/4 Box/File Pedestal Right (H3B handles, lock, Full modesty)

Model#	(L)	(B)	(E)	(K)	(R)	(W)	Weight	Cube	Price
MCCDQ72 4R	72"	36"	24"	21"	24"	30"	239	45	\$1,612

No keyboard tray. Worksurface black grommet standard. Upgrade grommet cover to silver, N/C.

Computer Corner, Curved, Box/Box/File Pedestal Right (H3B handles, lock, Full modesty)

Model#	(L)	(B)	(E)	(K)	(R)	(W)	Weight	Cube	Price
MCCDQ72C 4R	72"	36"	24"	21"	24"	30"	254	45	\$2,169

No keyboard tray. Worksurface black grommet standard. Upgrade grommet cover to silver, N/C.

Computer Corner, Curved, File/File Pedestal Right (H3B handles, lock, Full modesty)

Model#	(L)	(B)	(E)	(K)	(R)	(W)	Weight	Cube	Price
MCCDQ72D 4R	72"	36"	24"	21"	24"	30"	254	45	\$2,087

No keyboard tray. Worksurface black grommet standard. Upgrade grommet cover to silver, N/C.

Computer Corner, Curved, 3/4 Box/File Pedestal Left (H3B handles, lock, Full modesty)

Model#	(L)	(B)	(E)	(K)	(R)	(W)	Weight	Cube	Price
MCCDQ72 4L	72"	36"	24"	21"	24"	30"	239	45	\$1,612

No keyboard tray. Worksurface black grommet standard. Upgrade grommet cover to silver, N/C.

Computer Corner, Curved, Box/Box/File Pedestal Left (H3B handles, lock, Full modesty)

Model#	(L)	(B)	(E)	(K)	(R)	(W)	Weight	Cube	Price
MCCDQ72C 4L	72"	36"	24"	21"	24"	30"	254	45	\$2,169

No keyboard tray. Worksurface black grommet standard. Upgrade grommet cover to silver, N/C.

Computer Corner, Curved, File/File Pedestal Left (H3B handles, lock, Full modesty)

Model#	(L)	(B)	(E)	(K)	(R)	(W)	Weight	Cube	Price
MCCDQ72D 4L	72"	36"	24"	21"	24"	30"	254	45	\$2,087

No keyboard tray. Worksurface black grommet standard. Upgrade grommet cover to silver, N/C.

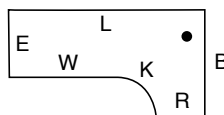

"L" Length along approach edge

"B" Back end panel

"E" End panel

"K" Keyboard space

"R" Return size to attach

"W" Workarea (kbrd to end)

maverick complete

CompuCorner Credenzas

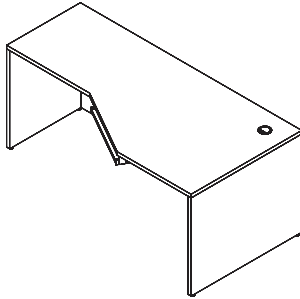

Computer Corner Shell (Full modesty), For Right Return

Model#	(L)	(B)	(E)	(K)	(R)	(W)	Weight	Cube	Price
MCCDN60 2R	60"	30"	20"	21"	20"	21"	184	32	\$1,144
MCCDN72 3R	72"	36"	20"	24"	20"	33"	213	45	\$1,326
MCCDN72 4R	72"	36"	24"	21"	24"	30"	213	45	\$1,371

Keyboard tray and worksurface black grommet standard. Upgrade grommet cover to silver, N/C.

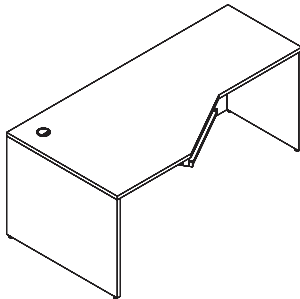

Computer Corner Shell (Full modesty), For Left Return

Model#	(L)	(B)	(E)	(K)	(R)	(W)	Weight	Cube	Price
MCCDN60 2L	60"	30"	20"	21"	20"	21"	184	32	\$1,144
MCCDN72 3L	72"	36"	20"	24"	20"	33"	213	45	\$1,326
MCCDN72 4L	72"	36"	24"	21"	24"	30"	213	45	\$1,371

Keyboard tray and worksurface black grommet standard. Upgrade grommet cover to silver, N/C.

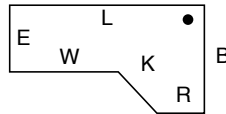

- "L" Length along approach edge
- "B" Back end panel
- "E" End panel
- "K" Keyboard space
- "R" Return size to attach
- "W" Workarea (kbrd to end)

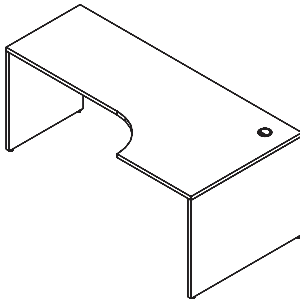

Computer Corner Shell, Curved (Full modesty), For Right Return

Model#	(L)	(B)	(E)	(K)	(R)	(W)	Weight	Cube	Price
MCCDNQ72 4R	72"	36"	24"	21"	24"	30"	213	45	\$1,371

Worksurface black grommet standard. No keyboard tray. Upgrade grommet cover to silver, N/C.

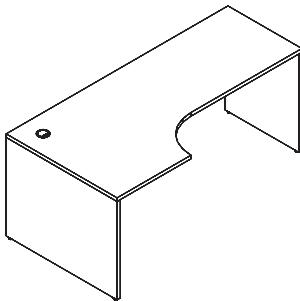

Computer Corner Shell, Curved (Full modesty), For Left Return

Model#	(L)	(B)	(E)	(K)	(R)	(W)	Weight	Cube	Price
MCCDNQ72 4L	72"	36"	24"	21"	24"	30"	213	45	\$1,371

Worksurface black grommet standard. No keyboard tray. Upgrade grommet cover to silver, N/C.

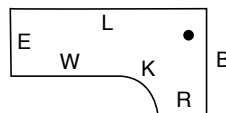

- "L" Length along approach edge
- "B" Back end panel
- "E" End panel
- "K" Keyboard space
- "R" Return size to attach
- "W" Workarea (kbrd to end)

CompuCorner Credenzas

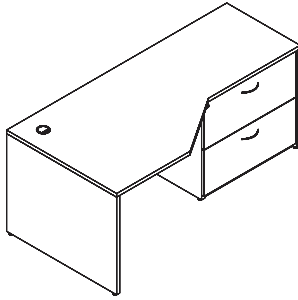

Computer Corner, Right 31" Lateral File (H3B handles, lock, full modesty)

Model#	(L)	(B)	(E)	(K)	(R)	(W)	Weight	Cube	Price
MCCD72LF 3R	72"	36"	20"	24"	20"	33"	249	45	\$2,166
MCCD72LF 4R	72"	36"	24"	21"	24"	30"	265	45	\$2,286

No keyboard tray and worksurface black grommet standard. Upgrade to H3S handles...N/C. Upgrade grommet cover to silver, N/C.

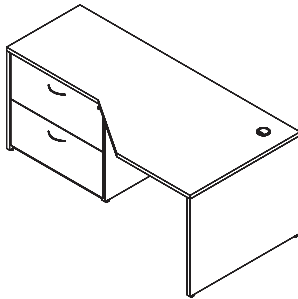

Computer Corner, Left 31" Lateral File (H3B handles, lock, full modesty)

Model#	(L)	(B)	(E)	(K)	(R)	(W)	Weight	Cube	Price
MCCD72LF 3L	72"	36"	20"	24"	20"	33"	249	45	\$2,166
MCCD72LF 4L	72"	36"	24"	21"	24"	30"	265	45	\$2,286

No keyboard tray and worksurface black grommet standard. Upgrade to H3S handles...N/C. Upgrade grommet cover to silver, N/C.

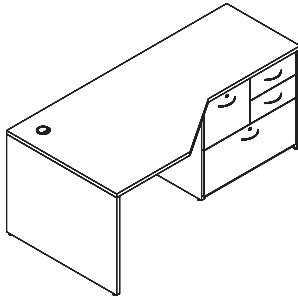

Computer Corner, Right 31" Personal Lateral File (H3B handles, 2 locks, full modesty)

Model#	(L)	(B)	(E)	(K)	(R)	(W)	Weight	Cube	Price
MCCD72PLF 3R	72"	36"	20"	24"	20"	33"	249	45	\$2,438
MCCD72PLF 4R	72"	36"	24"	21"	24"	30"	265	45	\$2,497

No keyboard tray and worksurface black grommet standard. Box drawers do not lock. Upgrade to H3S handles...N/C. Upgrade grommet cover to silver, N/C.

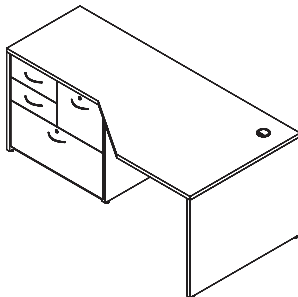

Computer Corner, Left 31" Personal Lateral File (H3B handles, 2 locks, full modesty)

Model#	(L)	(B)	(E)	(K)	(R)	(W)	Weight	Cube	Price
MCCD72PLF 3L	72"	36"	20"	24"	20"	33"	249	45	\$2,438
MCCD72PLF 4L	72"	36"	24"	21"	24"	30"	265	45	\$2,497

No keyboard tray and worksurface black grommet standard. Box drawers do not lock. Upgrade to H3S handles...N/C. Upgrade grommet cover to silver, N/C.

NOTE: Returns with personal lateral file, when ordering with APH1 handles (1) lock is standard.

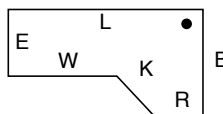

"L" Length along approach edge

"B" Back end panel

"E" End panel

"K" Keyboard space

"R" Return size to attach

"W" Workarea (kbrd to end)

maverick complete

Credenzas

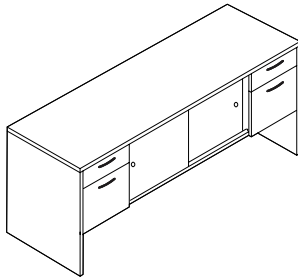

Credenza, Double Pedestal, Box/File Left and Right, Center Storage
(Sliding doors, Full modesty, H3B handles, 2 locks)

Model#	Depth	Width	Height	Weight	Cube	Price
MCC2060 2	20"	60"	29"	230	21	\$1,751
MCC2066 2	20"	66"	29"	240	23	\$2,025
MCC2072 2	20"	72"	29"	250	25	\$2,043
MCC2472 2	24"	72"	29"	270	30	\$2,156

Storage includes one adjustable 3/4"-thick shelf.
NOTE: Pedestal locks are inside doors.

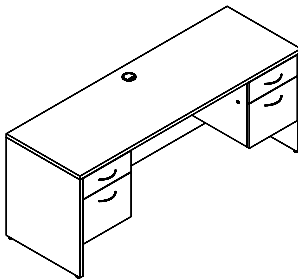

Credenza, Double Pedestal, Box/File Left and Right
(Knee space, Full modesty, H3B handles, 2 locks)

Model#	Depth	Width	Height	Weight	Cube	Price
MCC2060 3	20"	60"	29"	196	21	\$1,774
MCC2066 3	20"	66"	29"	205	23	\$2,055
MCC2072 3	20"	72"	29"	210	25	\$2,088
MCC2472 3	24"	72"	29"	230	30	\$2,134

Black grommet center top and modesty. Upgrade grommet cover to silver, N/C.

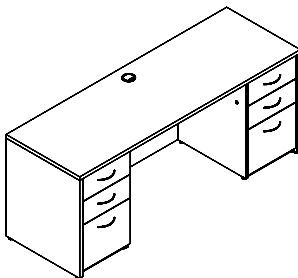

Credenza, Double Pedestal, Box/Box/File Left and Right
(Knee space, full modesty, H3B handles, 2 locks)

Model#	Depth	Width	Height	Weight	Cube	Price
MCCC2060 3	20"	60"	29"	245	21	\$2,493
MCCC2066 3	20"	66"	29"	255	23	\$2,777
MCCC2072 3	20"	72"	29"	265	25	\$2,806
MCCC2472 3	24"	72"	29"	290	30	\$2,854

Black grommet center top and modesty. Upgrade grommet cover to silver, N/C.
For left Box/Box/File and right File/File configuration use MCCC_ _ _ _ N/C.

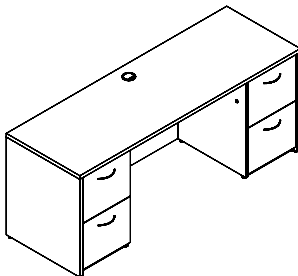

Credenza, Double Pedestal, File/File Left and Right
(Knee space, full modesty, H3B handles, 2 locks)

Model#	Depth	Width	Height	Weight	Cube	Price
MCCD2060 3	20"	60"	29"	245	21	\$2,379
MCCD2066 3	20"	66"	29"	255	23	\$2,667
MCCD2072 3	20"	72"	29"	265	25	\$2,696
MCCD2472 3	24"	72"	29"	290	30	\$2,743

Black grommet center top and modesty. Upgrade grommet cover to silver, N/C.

maverick complete

Credenzas

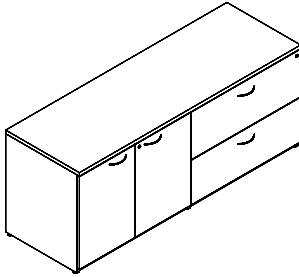

Credenza, Hinged Door Cabinet Left and Lateral File Right (H3B handles, 2 locks)

Model#	Depth	Width	Height	Weight	Cube	Price
MCC2072 9FP	20"	72"	29"	270	30	\$2,685
MCC2472 9FP	24"	72"	29"	290	30	\$2,753

Cabinet includes 1 adjustable shelf ¾" thick. For right Cabinet and left Lateral File specify N/C.

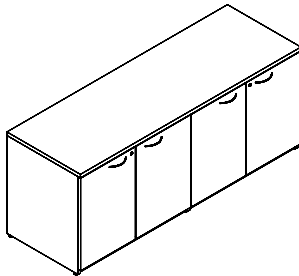

Credenza, Full Storage (4 full hinged doors, 2 adjustable shelves, H3B handles, 2 locks)

Model#	Depth	Width	Height	Weight	Cube	Price
MCC2048 1FP	20"	48"	29"	155	17	\$2,263
MCC2448 1FP	24"	48"	29"	175	20	\$2,364
MCC2060 1FP	20"	60"	29"	220	21	\$2,415
MCC2066 1FP	20"	66"	29"	240	23	\$2,595
MCC2072 1FP	20"	72"	29"	260	25	\$2,625
MCC2472 1FP	24"	72"	29"	295	30	\$2,829
MCC207236 1FP	20"	72"	36"	238	30	\$2,809
MCC247236 1FP	24"	72"	36"	265	36	\$2,943

Storage includes 1 adjustable shelf ¾" thick per side.

Note: H11 & H14 handles are installed vertically on 48" & 60"W credenzas.

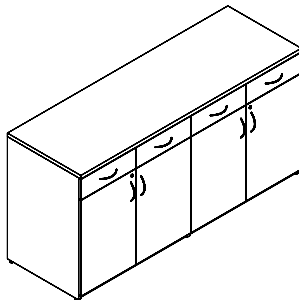

Buffet Credenza, 4 box drawers, 4 full hinged doors (H3B handles, 2 locks doors only)

Model#	Depth	Width	Height	Weight	Cube	Price
MCHDBC2036	20"	36"	36"	220	15	\$1,901
MCHDBC2436	24"	36"	36"	240	18	\$2,054
MCHDBC2060	20"	60"	36"	236	25	\$3,515
MCHDBC2460	24"	60"	36"	261	30	\$3,644
MCHDBC2072	20"	72"	36"	260	30	\$3,552
MCHDBC2472	24"	72"	36"	290	36	\$3,691

Storage includes 1 adjustable shelf ¾" thick per side.

36"W credenza: 2 box drawers, 2 hinged doors, 1 adjustable shelf, 1 lock.

Optional face locks available for box drawers, add MM FL...\$105 each.

Note: H11 & H14 handles do not fit 60"W buffet credenzas.

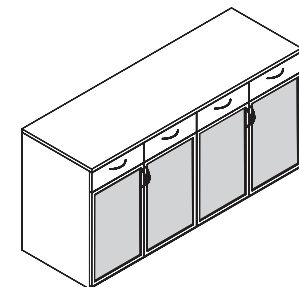

Buffet Credenza, 4 box drawers, 4 hinged frosted glass doors (H3B handles)

Model#	Depth	Width	Height	Weight	Cube	Price
MCHDBC2036G	20"	36"	36"	220	15	\$2,091
MCHDBC2436G	24"	36"	36"	240	18	\$2,236
MCHDBC2072G	20"	72"	36"	240	18	\$4,500
MCHDBC2472G	24"	72"	36"	290	36	\$4,636

Storage includes 1 adjustable shelf ¾" thick per side.

36"W credenza: 2 box drawers & 2 glass doors, 1 adjustable shelf.

Optional face locks available for box drawers, add MM FL...\$105 each. Locks N/A for glass doors.

Note: H11 & H14 handles do not fit 60"W buffet credenzas.

maverick complete

Hutches

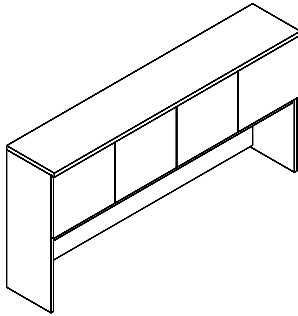

Hutch Four Doors with Fascia (18" below Fascia)

Model#	Depth	Width	Height	# Doors	Weight	Cube	Price
☞ MCH48WD	14"	48"	36"	4	130	14	\$1,555
☞ MCH60WD	14"	60"	36"	4	155	18	\$1,663
☞ MCH66WD	14"	66"	36"	4	167	20	\$1,795
☞ MCH72WD	14"	72"	36"	4	179	21	\$1,836
☞ Glass Doors MCH72WG	14"	72"	36"	4	179	21	\$2,537

Optional face locks (2 locks required), add MM FL...\$105 each. Locks N/A for glass doors.
 May be upgraded to 42" height, add MMUHH...\$237. Add tasklights and tackboards, see p. 92.
 Ends are 3/4" thick; doors overlay legs but are inset to the 1"-thick top.
 35lb. weight capacity distributed evenly.

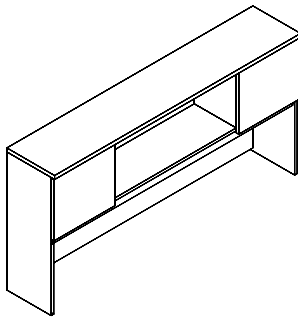

Hutch, Left and Right Door, Center Opening with Fascia (18" below Fascia)

Model#	Depth	Width	Height	# Doors	Weight	Cube	Price
MCH60W2D	14"	60"	36"	2	140	18	\$1,522
MCH66W2D	14"	66"	36"	2	152	20	\$1,595
MCH72W2D	14"	72"	36"	2	164	21	\$1,663

Optional face locks (2 locks required), add MM FL...\$105 each. Doors are same width as open space.
 May be upgraded to 42" height, add MMUHH...\$237. Add tasklights and tackboards, see p. 92.
 Ends are 3/4" thick; doors overlay legs but are inset to the 1"-thick top.
 35lb. weight capacity distributed evenly.

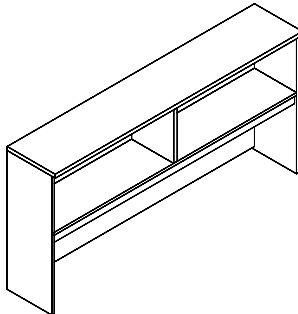

Hutch No Doors with Fascia (18" below Fascia)

Model#	Depth	Width	Height	Weight	Cube	Price
☞ MCH48ND	14"	48"	36"	115	14	\$1,171
☞ MCH60ND	14"	60"	36"	135	18	\$1,210
☞ MCH66ND	14"	66"	36"	148	20	\$1,301
☞ MCH72ND	14"	72"	36"	160	21	\$1,422

May be upgraded to 42" height, add MMUHH...\$237. Add tasklights, fascia and tackboards, see p. 92.
 Ends are 3/4" thick; doors overlay legs but are inset to the 1"-thick top.
 35lb. weight capacity distributed evenly.

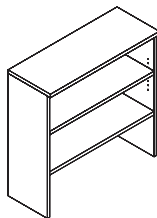

Bookcase Hutch, Full Back Panel

(One adjustable shelf, One fixed shelf, 1"-thick shelves) Bottom Clearance 12"H

Model#	Depth	Width	Height#	Shelves	Weight	Cube	Price
MCBCH31	14"	31"	36"	2	72	11	\$579
☞ MCBCH	14"	36"	36"	2	72	11	\$607

May be upgraded to 42" height, add MMUHH...\$237. 12"H Bottom clearance does not change. See p. 92.
 Ends are 3/4" thick; legs are inset to the 1"-thick top. Width coordinates with lateral files and utility cabinets.
 35lb. weight capacity distributed evenly.

NOTE: If hutch is placed on L-unit return, 1/2 leg support is required, add MMSPT \$151.

Wall Mount Cabinets

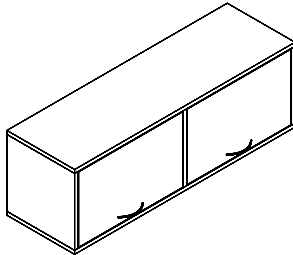

Wall Mount Overhead Cabinet With Flip Doors, H3B handles
(35lb. weight capacity)

Model#	Depth	Width	Height	# of Doors	Weight	Cube	Price
MCCFOHB30	14 3/4"	30"	16"	1	110	7	\$1,111
MCCFOHB36	14 3/4"	36"	16"	1	110	7	\$1,255
MCCFOHB48	14 3/4"	48"	16"	2	110	7	\$1,500

Optional locks (two required on 48"W) add MMFL...\$105 each.
Requires professional installation and must be mounted to wall stud.
35lb. weight capacity distributed evenly.

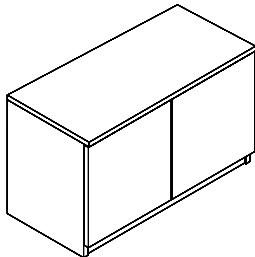

Wall Mount Overhead Cabinet with Hinged Door Overlay, Finger pull, Fascia
(35lb. weight capacity)

Model#	Depth	Width	Height	# of Doors	Weight	Cube	Price
MCCFOHD30	14 3/4"	30"	18 1/2"	2	110	7	\$1,063
MCCFOHD36	14 3/4"	36"	18 1/2"	2	110	7	\$1,092
MCCFOHD42	14 3/4"	42"	18 1/2"	2	120	9	\$1,254
MCCFOHD48	14 3/4"	48"	18 1/2"	4	120	9	\$1,293

* Wall mount overhead storage includes fascia. Optional handles may be added, see p. 94.
Optional face lock (two required on 42"W and 48"W) MMFL add...\$105 each.
Requires professional installation and must be mounted to wall stud.
35lb. weight capacity distributed evenly.

Storage

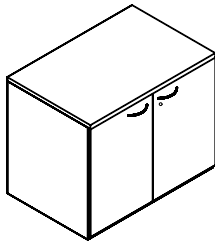

Hinged Door Utility Cabinet (H3B handle, one 3/4"-thick adjustable shelf, lock)

Model#	Depth	Width	Height	Weight	Cube	Price
MCHDC2036	20"	36"	29"	115	13	\$1,200
MCHDC2042	20"	42"	29"	165	15	\$1,263
MCHDC2436	24"	36"	29"	175	15	\$1,364
MCHDC2442	24"	42"	29"	180	18	\$1,467
MCHDC2436G	24"	36"	29"	175	18	\$1,688

Glass Doors

Width coordinates with bookcase hutch. Locks N/A for Glass doors.
Note: MCHDC2436G handles are installed vertically.



Single Storage Cabinet, Right Door (Three adjustable shelves, H3B handles, lock)

Model#	Depth	Width	Height	Weight	Cube	Price
MCSTS1665R	20"	16"	65"	185	12	\$1,446

Adjustable shelves are 3/4"-thick.



Single Storage Cabinet, Left Door (Three adjustable shelves, H3B handles, lock)

Model#	Depth	Width	Height	Weight	Cube	Price
MCSTS1665L	20"	16"	65"	185	12	\$1,446

Adjustable shelves are 3/4"-thick.

maverick complete

Storage

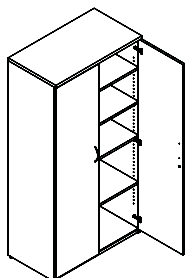

Double Storage Cabinet (Adjustable shelves, H3B handles, lock)

Model#	Depth	Width	Height	# Shelves	Weight	Cube	Price
MCST3642	20"	36"	42"	2	208	18	\$1,616
MCST3665	20"	36"	65"	3	290	27	\$2,171
MCST3672	20"	36"	72"	4	370	30	\$2,430
MCST3684	20"	36"	84"	5	298	35	\$2,726
MCST243665	24"	36"	65"	3	290	27	\$2,404
MCST243672	24"	36"	72"	4	370	30	\$2,638

Adjustable shelves are 3/4"-thick.
 Cabinets 60"H & higher are made with required fixed shelf for locking.
 Note: Cabinets 42"H are standard with horizontal handles.

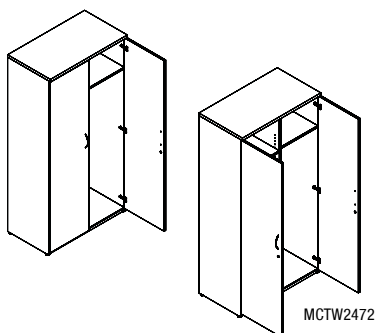

Wardrobe Cabinet (H3B handles, coat rack, one fixed shelf, 1-lock)

Model#	Depth	Width	Height	Weight	Cube	Price
MCWC3665	24"	36"	65"	309	33	\$1,902
MCWC3672	24"	36"	72"	325	36	\$2,191
MCTW2472	24"	36"	72"	286	36	\$2,859

MCTW2472 Includes: Left 4-adjustable shelves 3/4"-thick, right wardrobe, 2 locks.

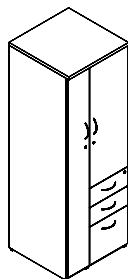

Personal Storage Cabinet Right Door, 2 adjustable shelves and BBF, Left Long Door
 2 adjustable shelves 3/4"-thick. (H3B handles, 3 face locks)

Model#	Depth	Width	Height	Weight	Cube	Price
MCWCP2465	24"	24"	65"	309	22	\$3,105
MCWCP2472	24"	24"	72"	325	24	\$3,324

Coat rack in long door compartment. Both doors face lock, pedestal face lock.
 For right Long door and left BBF must specify N/C.

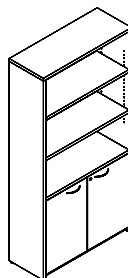

Bookcase with Storage Cabinet (H3B handles, lock, 1"-thick adjustable shelves)

Model#	Depth	Width	Height	# Shelves	Weight	Cube	Price
MCBCD3660	14"	36"	60"	2	135	18	\$1,739
MCBCD3672	14"	36"	72"	3	145	21	\$1,796
MCBCD3684	14"	36"	84"	4	155	25	\$2,051

Adjustable shelf inside doors are 3/4"-thick.

maverick complete

Storage

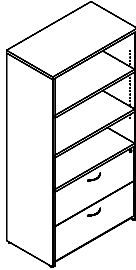

Bookcase with 36" Wide Lateral File (Adjustable shelves, H3B handles, lock)

Model#	Depth	Width	Height	# Shelves	Weight	Cube	Price
MCBCLF3660	20"	36 1/2"	60"	1	224	25	\$2,217
MCBCLF3672	20"	36 1/2"	72"	2	260	30	\$2,328
MCBCLF3684	20"	36 1/2"	84"	3	281	35	\$2,561

Adjustable shelves are 1"-thick.

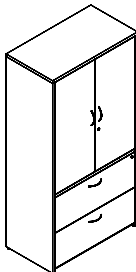

Bookcase with 36" Wide Lateral File & Doors (Adjustable shelves, H3B handles, 2 locks)

Model#	Depth	Width	Height	# Shelves	Weight	Cube	Price
MCBCLF3672WD	20"	36 1/2"	72"	2	300	30	\$2,954
MCBCLF3684WD	20"	36 1/2"	84"	3	331	35	\$3,275

Adjustable shelves are 1"-thick.

Bookcases

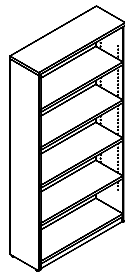

Bookcase (1"-thick adjustable shelves)

Model#	Depth	Width	Height	# Shelves	Weight	Cube	Price
☞ MCBC3630	12"	36"	29"	1	61	18	\$623
☞ MCBC3648	12"	36"	48"	2	86	12	\$840
☞ MCBC3660	12"	36"	60"	3	107	15	\$1,010
☞ MCBC3665	12"	36"	65"	3	111	17	\$1,053
☞ MCBC3672	12"	36"	72"	4	128	18	\$1,094
☞ MCBC3684	12"	36"	84"	5	137	21	\$1,367

For additional adjustable shelf, add MMSH1 \$151 ea. Includes 4-pins per shelf. Adjustable shelves recommended weight is 20 lbs each, distributed evenly.

maverick complete

Files

(All drawers are 16"D except vertical files)

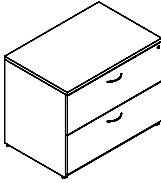

2-Drawer Lateral File (H3B handles, lock) Anti-Tip Interlock

Model#	Depth	Width	Height	Weight	Cube	Price
MCLF2031	20"	31"	29"	135	11	\$1,433
MCLF2431	24"	31"	29"	147	13	\$1,469
☞ MCLF202	20"	36"	29"	160	13	\$1,564
☞ MCLF242	24"	36"	29"	176	15	\$1,631

Includes Anti-Tip Interlock.

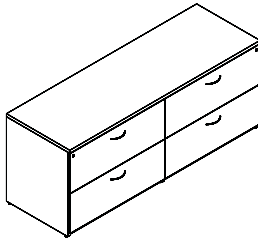

4-Drawer Double Lateral File (H3B handles, 2 locks) 2 Anti-Tip Interlock

Model#	Depth	Width	Height	Weight	Cube	Price
MCLF202+2	20"	72"	29"	330	25	\$3,041
MCLF242+2	24"	72"	29"	335	30	\$3,153

Includes 2 Anti-Tip Interlocks.

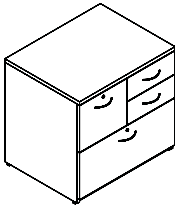

Personal Lateral File 31" W (H3B handles, 2 locks)

Model#	Depth	Width	Height	Weight	Cube	Price
MCPLF20	20"	31"	29"	189	11	\$1,511
MCPLF24	24"	31"	29"	205	13	\$1,578

Box drawers do not lock. If ordered APH1 handles (1) lock is standard.

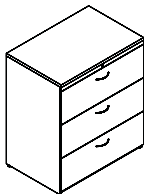

3-Drawer Lateral File (H3B handles, lock) Anti-Tip Interlock

Model#	Depth	Width	Height	Weight	Cube	Price
2⊗ MCLF203	20"	36"	43"	240	18	\$2,305
2⊗ MCLF243	24"	36"	43"	264	22	\$2,395

REQUIRES 2⊗ LEAD TIME.

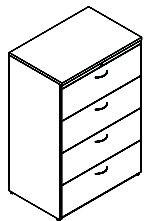

4-Drawer Lateral File (H3B handles, lock) Anti-Tip Interlock

Model#	Depth	Width	Height	Weight	Cube	Price
2⊗ MCLF204	20"	36"	55"	330	23	\$2,949
2⊗ MCLF244	24"	36"	55"	335	28	\$3,082

REQUIRES 2⊗ LEAD TIME.

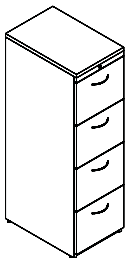

MCVF4

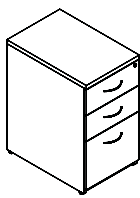

MCVFC

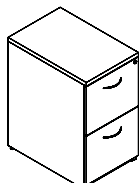

MCVF2

Vertical Files (H3B handles, lock)

Model#	Depth	Width	Height	20"D Drawers	Weight	Cube	Price
☞ MCVF2	24"	16"	29"	2	160	7	\$1,045
☞ MCVFC	24"	16"	29"	3	160	7	\$1,147
MCVF2LGL	24"	19"	29"	2	172	8	\$1,178
2⊗ MCVF4	24"	16"	55"	4	180	7	\$2,188
2⊗ MCVF4LGL	24"	19"	55"	4	190	8	\$2,364

4 Drawer vertical files require 2⊗ LEAD TIME.
Anti-tip interlock is standard on 4-drawer vertical files only.

NOTE: All files recommended capacity is 75%, do not overload.

See available accessories and upgrades, pp. 93-97.

maverick complete

Pedestals - Freestanding

NOTE: Pedestals below cannot be used for Apex series. Email us for quote.

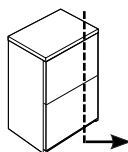
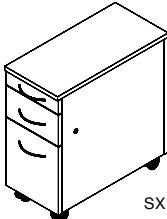
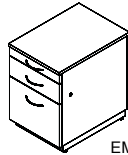
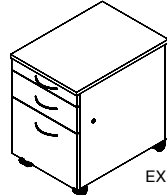
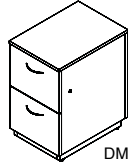
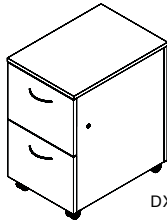
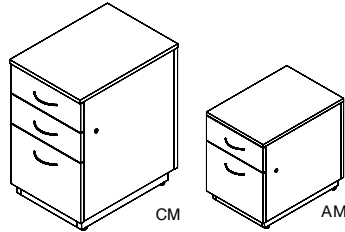
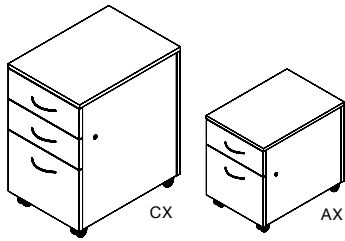

Mobile Pedestal, Box/Box/File or Box/File with Casters (H3B handles, Right lock)

Model#	Depth	Width	Height	Drawer Depth	Weight	Cube	Price
MCPEDAX	23"	16"	22"	20	56	5	\$936
MCPEDAX20	19"	16"	22"	16	56	5	\$918
MCPEDCX	23"	16"	27 5/8"	20	90	6	\$1,125
MCPEDCX20	19"	16"	27 5/8"	16	80	6	\$1,108

Pedestal, Box/Box/File or Box File with Kickbase 2 1/2" H. (H3B handles, Right lock)

Model#	Depth	Width	Height	Drawer Depth	Weight	Cube	Price
MCPEDAM	23"	16"	22"	20	50	4	\$936
MCPEDAM20	19"	16"	22"	16	50	4	\$918
MCPEDCM	23"	16"	27 5/8"	20	90	6	\$1,125
MCPEDCM20	19"	16"	27 5/8"	16	80	6	\$1,108

1 convenience tray (MMBPT) is provided for BBF. 1 file bar is provided. Fully finished, letter size.

Mobile Pedestal, File/File with Casters (H3B handles, Right lock)

Model#	Depth	Width	Height	Drawer Depth	Weight	Cube	Price
MCPEDDX	23"	16"	27 5/8"	20	90	6	\$1,080
MCPEDDX20	19"	16"	27 5/8"	16	80	6	\$1,059

Pedestal, File/File with Kickbase 2 1/2" H. (H3B handles, Right lock)

Model#	Depth	Width	Height	Drawer Depth	Weight	Cube	Price
MCPEDDM	23"	16"	27 5/8"	20	90	6	\$1,080
MCPEDDM20	19"	16"	27 5/8"	16	80	6	\$1,059

2 file bars are provided. Fully finished, letter size.

Mobile Pedestal, Pencil/Box/File with Casters (H3B handles, Right lock)

Model#	Depth	Width	Height	Drawer Depth	Weight	Cube	Price
MCPEDEX	23"	16"	24"	20	90	6	\$1,125
MCPEDEX20	19"	16"	24"	16	80	6	\$1,108

Pedestal, Pencil/Box/File with Kickbase 2 1/2" H. (H3B handles, Right lock)

Model#	Depth	Width	Height	Drawer Depth	Weight	Cube	Price
MCPEDEM	23"	16"	24"	20	90	6	\$1,125
MCPEDEM20	19"	16"	24"	16	80	6	\$1,108

Locks box/file only. 1 file bar provided. Fully finished, letter size.

Slim Mobile Pedestal Pencil/Box/File (H3B handles, Right lock)

Model#	Depth	Width	Height	Drawer Depth	Weight	Cube	Price
MCPEDSX	23"	10 1/2"	24"	20"	90	5	\$1,125
MCPEDSX20	19"	10 1/2"	24"	16"	80	5	\$1,108

1 file bar provided. Fully finished, letter size. H11 & H14 handles do not fit. Legal width N/A. Locks box/file only.

Upgrade Pedestals from Standard Width to Legal Width

Model#	Depth	Width	Height	Weight	Cube	Price
MMUPEDLGL	no change	19"	no change	128	8	\$133

Depth and height does not change. Option to upgrade is available for all pedestals above. Upgrade N/A for Slim Mobile Pedestal.

NOTE: Maverick East only, face lock location is standard.
APH1 handles do not fit on pencil drawers, N/A.

See available accessories and upgrades, pp. 93-97.

Statement of Line

RECEPTION



Reception - Single Ped
Single ped, desk only transaction
(RCAS)

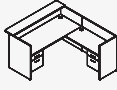

Reception - "L" Shape
Desk transaction counter only
(RCAX)

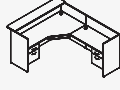

Reception - "L" Shape Computer
Desk transaction counter only
(RCDX)

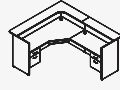

Reception - "L" Shape
Transaction counter on desk & return
(RCAL)

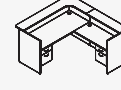

Reception - "L" Shape Computer
Transaction counter on desk & return
(RCDL)



Reception - Double Ped
Desk transaction Counter
(RCAD)

NOTES:

- Before ordering, ensure that the building and room access, including elevators, will accommodate furniture of this size. Use of pin-and-cam construction does facilitate some disassembly.
- Details of front transaction counter vary by series as do pedestals.
- Handles and locks standards vary by series.

How to Order Reception Units

WORKSURFACE UNITS: RECEPTION UNITS

1. Product number: **MC** **RCAL** **36** **72** **L**

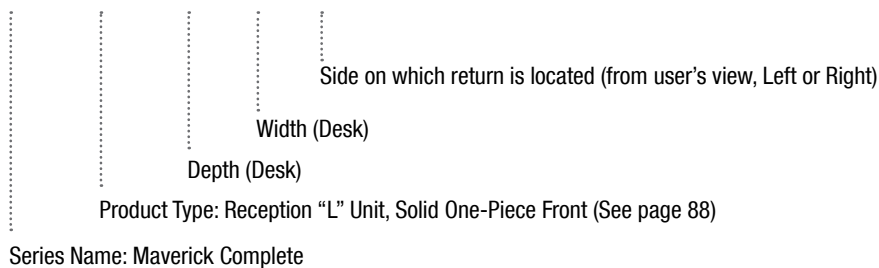

2. Specify worksurface color. Matching color edge and counter top is standard.
3. Specify counter top color. Matching color edge is standard.
4. Specify chassis color. Matching color edge is standard. Modesty color same as chassis is standard.
5. Specify drawer front color. Matching color edge is standard. For two colors, add \$133 list.
6. Specify handle option. H3B is standard if none specified. (Handles H11, H30, & APH1 charges apply)
7. Specify other accessories and upgrade options. See page 93-97.

STANDARD HANDLE OPTIONS

H3B is standard unless otherwise specified.



Crescent Black
(MMH3B)



Crescent Silver
(MMH3S)



Elliptical Black
(MMH5B)



Elliptical Silver
(MMH5S)



Crescent Textured Nickel
(MMH6)



Flared Nickel
(MMH7)



Bow Handle
(MMH8)



Curved Handle
(MMH9)



Bar Square Handle
(MMH10B)



Bar Square Handle
(MMH10S)



Bar Handle
(MMH14)



GROMMET

Black grommet standard where shown. Upgrade to silver color, N/C.

Risers, Desks and Returns

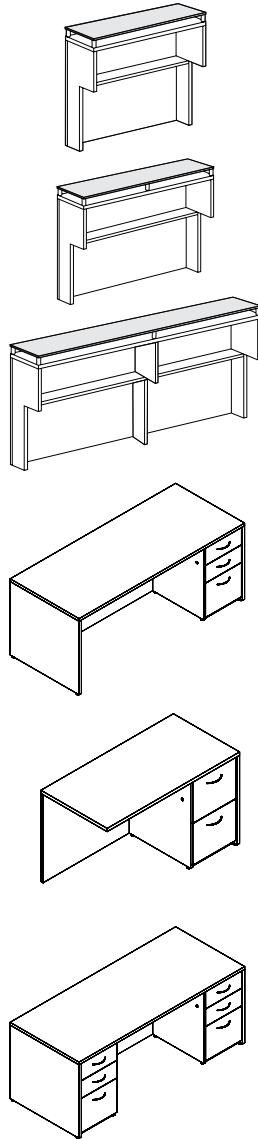

Riser Clear glass counter top, 4 aluminum spacers

Model#	Depth	Width	Height	Weight	Cube	Price
MCRB3632G	12"	36"	32"	89	16	\$1,997

Riser Clear glass counter top, 6 aluminum spacers

Model#	Depth	Width	Height	Weight	Cube	Price
MCRB4832G	12"	48"	32"	89	17	\$2,279

Riser Clear glass counter top, center leg support, 6 aluminum spacers

Model#	Depth	Width	Height	Weight	Cube	Price
MCRB6032G	12"	60"	32"	92	20	\$2,849
MCRB7232G	12"	72"	32"	124	24	\$3,401

Single Pedestal Desk Flush Full Modesty Panel, Box/Box/File (Specify left or right, H3B handles, lock)

Model#	Depth	Width	Height	Weight	Cube	Price
MCRSC3060R	30"	60"	29"	224	32	\$2,104
MCRSC3060L	30"	60"	29"	224	32	\$2,104
MCRSC3072R	30"	72"	29"	267	45	\$2,266
MCRSC3072L	30"	72"	29"	267	45	\$2,266

Return Full Modesty Panel, File/File (Specify left or right, H3B handles, lock)

Model#	Depth	Width	Height	Weight	Cube	Price
MCRRD2042R	20"	42"	29"	125	15	\$1,908
MCRRD2042L	20"	42"	29"	125	15	\$1,908
MCRRD2048R	20"	48"	29"	150	17	\$1,930
MCRRD2048L	20"	48"	29"	150	17	\$1,930
MCRRD2442R	24"	42"	29"	150	18	\$2,039
MCRRD2442L	24"	42"	29"	150	18	\$2,039
MCRRD2448R	24"	48"	29"	160	20	\$2,081
MCRRD2448L	24"	48"	29"	160	20	\$2,081

Double Pedestal Desk, Flush Full Modesty Panel, Left and Right Box/Box/File (H3B handles, 2 locks)

Model#	Depth	Width	Height	Weight	Cube	Price
MCRDC3072	30"	72"	29"	314	38	\$2,981
MCRDC3672	36"	72"	29"	337	45	\$3,001

Notes for risers, desks and returns:

- Flush modesty panel on desk. Pedestals on desks and returns are full to floor.
- Desks & Returns are designed (pin & cam) to accept risers. Risers add 6" to overall depth.
- Risers can be placed on desks of same width or longer width. For longer width, specify left or right.
- For Risers smaller than desk width: Must specify riser placement left or right side.
- **REQUIRES 4-WEEK LEAD TIME.**

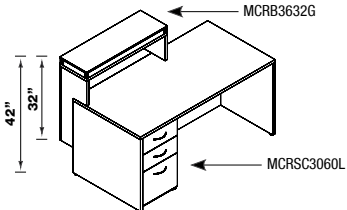
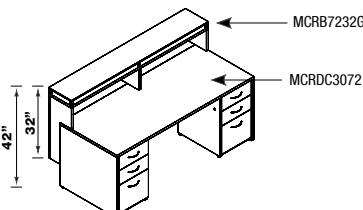
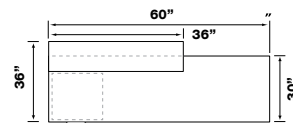
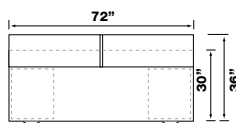
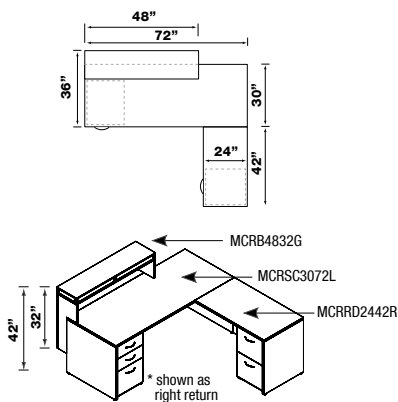

NOTE: Risers are designed for the style of desks and returns on this page. Specify user left or right side riser placement.

maverick complete

Reception Units L-Shapes (Desk and Return with Transaction Counter Top)

NOTE: Before ordering, ensure that the building and room access, including elevators, will accommodate furniture of this size. Use of pin-and-cam construction does facilitate some reassembly. Upgrade to Full Pedestals, See page 90.

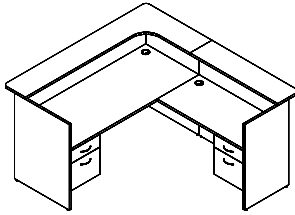

Reception "L" Unit, Solid One-Piece Front, Right Return 24" x 48"
(2 locks, H3B handles, 2 grommets)

Model#	Depth	Width	Height	Weight	Cube	Price
*MRCAL3060R	72"	66"	42"	400	92	\$4,268
MRCAL3072R	84"	78"	42"	435	104	\$4,564
MRCAL3672R	90"	78"	42"	439	115	\$4,735
MRCAL3684R	90"	90"	42"	522	127	\$5,127

Counter top is 12" deep. Counter top approach overhang is 6". Worksurface black grommets standard. Fan top on approach side of desk counter may be specified at no upcharge, insert F before C (e.g. MCRFCAL3060R). Transaction counter to desktop clearance is 11 3/4". Upgrade grommet cover to silver, N/C.
*MRCAL3060R comes with a 20"x36" right return.

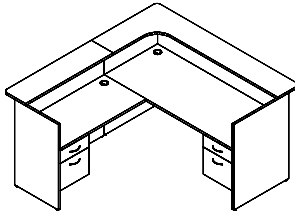

Reception "L" Unit, Solid One-Piece Front, Left Return 24" x 48"
(2 locks, H3B handles, 2 grommets)

Model#	Depth	Width	Height	Weight	Cube	Price
*MRCAL3060L	72"	66"	42"	400	92	\$4,268
MRCAL3072L	84"	78"	42"	435	104	\$4,564
MRCAL3672L	90"	78"	42"	439	115	\$4,735
MRCAL3684L	90"	90"	42"	522	127	\$5,127

Counter top is 12" deep. Counter top approach overhang is 6". Worksurface black grommets standard. Fan top on approach side of desk counter may be specified at no upcharge, insert F before C (e.g. MCRFCAL3060L). Transaction counter to desktop clearance is 11 3/4". Upgrade grommet cover to silver, N/C.
*MRCAL3060L comes with a 20"x36" left return.

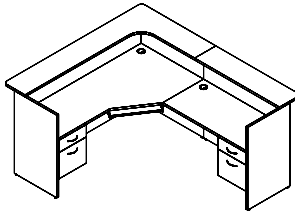

Computer Reception "L" Unit, Solid One-Piece Front, Right Return 24" x 48"
(2 locks, H3B handles, 2 grommets)

Model#	Depth	Width	Height	Weight	Cube	Price
MRCSDL3672R	90"	78"	42"	435	88	\$4,735

Counter top is 12" deep. Counter top approach overhang is 6". Worksurface black grommets and keyboard tray standard. Fan top to approach side of desk counter may be specified at no upcharge, insert F before C (e.g. MCRFCSDL3672R). Transaction counter to desktop clearance is 11 3/4". Upgrade grommet cover to silver, N/C.

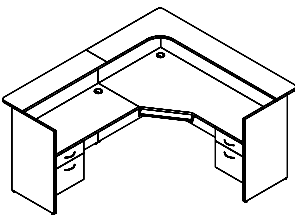

Computer Reception "L" Unit, Solid One-Piece Front, Left Return 24" x 48"
(2 locks, H3B handles, 2 grommets)

Model#	Depth	Width	Height	Weight	Cube	Price
MRCSDL3672L	90"	78"	42"	435	88	\$4,735

Counter top is 12" deep. Counter top approach overhang is 6". Worksurface black grommets and keyboard tray standard. Fan top to approach side of desk counter may be specified at no upcharge, insert F before C (e.g. MCRFCSDL3672L). Transaction counter to desktop clearance is 11 3/4". Upgrade grommet cover to silver, N/C.

Notes on standard woodgrain directions:

- The one-piece vertical front on the desk of the unit will display the woodgrain running horizontally (except 60")
- On other vertical surfaces, the woodgrain runs vertically
- Worksurface woodgrain on desk runs left-to-right
- The return worksurface grain direction coordinates with the desk surface, running from user's side to the approach side
- Transaction counter woodgrain runs the same direction as the worksurface woodgrain

See available accessories and upgrades, p. 91, pp. 93-97.

Reception Units L-Shapes and Reception Desks (Desk-Only Transaction with Counter Top)

NOTE: Before ordering, ensure that the building and room access, including elevators, will accommodate furniture of this size. Use of pin-and-cam construction does facilitate some reassembly. Upgrade to Full Pedestals, See page 90.

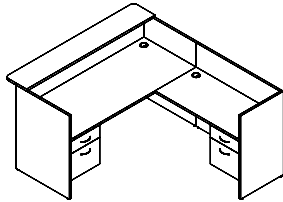

Reception "L" Unit, Solid One-Piece Front, Right Return 24" x 48"*
(Desk only with counter top, 2 locks, H3B handles, 2 grommets)

Model#	Depth	Width	Height	Weight	Cube	Price
MCRCA3060R*	72"	60"	42"	390	92	\$4,008
MCRCA3072R	84"	72"	42"	425	92	\$4,239
MCRCA3672R	90"	72"	42"	430	92	\$4,672

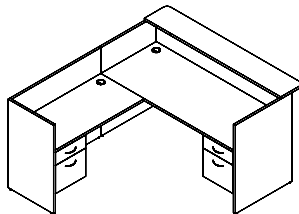

Reception "L" Unit, Solid One-Piece Front, Left Return 24" x 48"*
(Desk only with counter top, 2 locks, H3B handles, 2 grommets)

Model#	Depth	Width	Height	Weight	Cube	Price
MCRCA3060L*	72"	60"	42"	390	92	\$4,008
MCRCA3072L	84"	72"	42"	425	92	\$4,239
MCRCA3672L	90"	72"	42"	430	92	\$4,672

Counter top is 12" deep. Counter top approach overhang is 6". Worksurface black grommets standard. Fan top on approach side of desk counter may be specified at no upcharge, insert F before C (e.g. MCRFCAX3060R) Transaction counter to desktop clearance is 11 3/4". *MMRCA3060 comes with a 20"x 36" return. Upgrade grommet cover to silver, N/C.

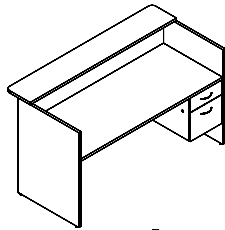

Reception Single Pedestal Desk, BF Right
(Desk only with counter top, lock, H3B handles, left grommet)

Model#	Depth	Width	Height	Weight	Cube	Price
MRCAS3060R	36"	60"	42"	232	53	\$2,608
MRCAS3072R	36"	72"	42"	250	63	\$2,725

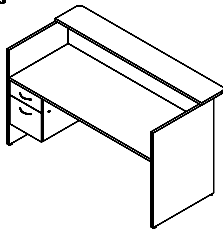

Reception Single Pedestal Desk, BF Left
(Desk only with counter top, lock, H3B handles, right grommet)

Model#	Depth	Width	Height	Weight	Cube	Price
MRCAS3060L	36"	60"	42"	232	53	\$2,608
MRCAS3072L	36"	72"	42"	250	63	\$2,725

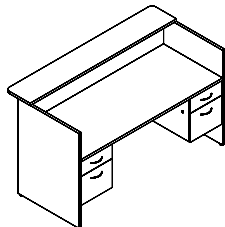

Reception Double Pedestal Desk, Left & Right BF
(Desk only with counter top, H3B handles, 2 locks, no grommet)

Model#	Depth	Width	Height	Weight	Cube	Price
MRCAD3072	36"	72"	42"	250	63	\$3,237

Counter top is 12" deep. Counter top approach overhang is 6". Worksurface black grommets standard. Fan top on approach side of desk counter may be specified at no upcharge, insert F before C (e.g. MCRFCAS3060R) Transaction counter to desktop clearance is 11 3/4". Upgrade grommet cover to silver, N/C.

Notes on standard woodgrain directions:

- The one-piece vertical front on the desk of the unit will display the woodgrain running horizontally (except 60")
- On other vertical surfaces, the woodgrain runs vertically
- Worksurface woodgrain on desk runs left-to-right
- The return worksurface grain direction coordinates with the desk surface, running from user's side to the approach side
- Transaction counter woodgrain runs the same direction as the worksurface woodgrain

See available accessories and upgrades, p. 91, pp. 93-97.

maverick complete

Reception Units Computer L-Shapes Desks & Return (Desk-Only Transaction with Counter Top)

NOTE: Before ordering, ensure that the building and room access, including elevators, will accommodate furniture of this size. Use of pin-and-cam construction does facilitate some reassembly. Upgrade to Full Pedestals, See below.

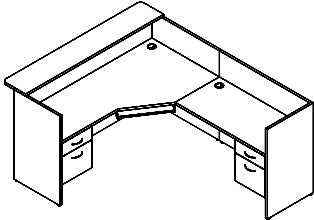

Computer Reception "L" Unit, Solid One-Piece Front, Right Return 24" x 48"
(Desk only with counter top, 2 locks, H3B handles, 2 grommets)

Model#	Depth	Width	Height	Weight	Cube	Price
MCRCDX3672R	90"	72"	42"	425	88	\$4,239

Counter top is 12" deep. Counter top approach overhang is 6". Worksurface black grommets and keyboard tray standard. Fan top on approach side of desk counter may be specified at no upcharge, insert F before C (e.g. MCRFCDX3672R). Desk counter only.
Transaction counter-to-desktop clearance is 11 3/4". Upgrade grommet cover to silver, N/C.

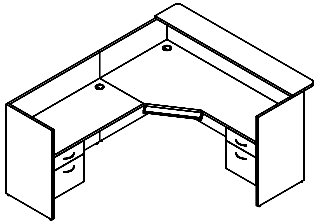

Computer Reception "L" Unit, Solid One-Piece Front, Left Return 24" x 48"
(Desk only with counter top, 2 locks, H3B handles, 2 grommets)

Model#	Depth	Width	Height	Weight	Cube	Price
MCRCDX3672L	90"	72"	42"	425	88	\$4,239

Counter top is 12" deep. Counter top approach overhang is 6". Worksurface black grommets and keyboard tray standard. Fan top on approach side of desk counter may be specified at no upcharge, insert F before C (e.g. MCRFCDX3672L). Desk counter only.
Transaction counter-to-desktop clearance is 11 3/4". Upgrade grommet cover to silver, N/C.

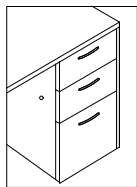

MCUPEDC

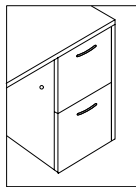

MCUPEDD

Upgrade to Full Pedestals (Pedestal upgrade for receptions only, H3B handles, lock)

Model#	Depth	Width	Height	Weight	Cube	Price
MCUPEDC	19"	15 3/4"	25 3/16"	75	6	\$403 ea.
	(Upgrade from BF to BBF)					
MCUPEDD	19"	15 3/4"	25 3/16"	75	6	\$347 ea.
	(Upgrade from BF to FF)					

Full Pedestal to floor.

Notes on standard woodgrain directions:

- The one-piece vertical front on the desk of the unit will display the woodgrain running horizontally (except 60")
- On other vertical surfaces, the woodgrain runs vertically
- Worksurface woodgrain on desk runs left-to-right
- The return worksurface grain direction coordinates with the desk surface, running from user's side to the approach side
- Transaction counter woodgrain runs the same direction as the worksurface woodgrain

maverick complete

STANDARD HANDLE OPTIONS FOR RECEPTION UNITS

H3B is standard if none specified.



Crescent Black
(MMH3B)



Crescent Silver
(MMH3S)



Elliptical Black
(MMH5B)



Elliptical Silver
(MMH5S)



Crescent Textured Nickel
(MMH6)



Flared Nickel
(MMH7)



Bow Handle
(MMH8)



Curved Handle
(MMH9)



Bar Square Handle
(MMH10B)



Bar Square Handle
(MMH10S)



Bar Handle
(MMH14)



Upgrade Grommet Color from Standard Black to Silver

Model#	Color	Depth	Width	Surface Hole Diameter	Price
MMUGR234	Silver Plastic	3"	3"	2 3/4"	No Charge

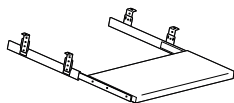

Keyboard Tray, Rollout (Specify laminate color)

Model#	Depth	Width	Height	Weight	Cube	Price
MMKB	16"	21"	3"	10	.5	\$181

maverick complete

Upgrades and Accessories for Hutches

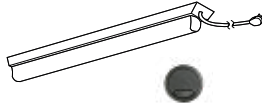

Tasklight (Black, one light only) One Grommet on Hutch Back Panel

Model#	Depth	Width	Height	Weight	Cube	Price
MCTSKLTX	7/8"	24 1/2"	1 7/8"	2	.1	\$324

72" hutch takes 2 lights. For extra tasklight add MMTSKLTX \$259.

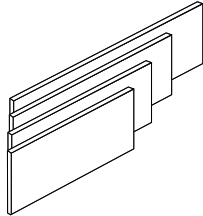

Hutch Tackboards

Model#	Depth	Width	Height	Hutch Width	Weight	Cube	Price
MMTKBD30	1/2"	30"	14 1/4"	36"	9	.5	\$524
MMTKBD36	1/2"	36"	14 1/4"	42"	9	.5	\$544
MMTKBD42	1/2"	42"	14 1/4"	48"	12	.6	\$564
MMTKBD48	1/2"	48"	14 1/4"	54"	12	.6	\$607
MMTKBD54	1/2"	54"	14 1/4"	60"	15	.7	\$645
MMTKBD60	1/2"	60"	14 1/4"	66"	17	.8	\$685
MMTKBD66	1/2"	66"	14 1/4"	72"	19	1	\$732
MMTKBD72	1/2"	72"	14 1/4"	78"	21	1	\$894

Tackboards fit hutch width 6" larger, e.g., MMTKBD66 fits 72" wide hutch.
 For fabric color choice, see inside back cover.
 For COM fabric, add \$221 list each tackboard. Required yardage to be provided by customer.

Fabric Chart (Uses Guilford of Maine)

STANDARD FABRICS

Tempest 2120...Zebra 015, Silk 045 **Sprite 2671...**Snow 7040, Linen 7010
Anchorage 2335...Sunshine 2082, Waterfall 2691, Green Apple 2087, Aubergine 2036,
 Goose 2049, Onyx 2016, Red Delicious 2014
Metro 3077...Storefront 030, Skyscraper 022 **Cape Cod 3073...**Linen 7031, Surf 7062
Metallation 5118...Chrome 1676, Polished Pewter 1678
Cadence 5595...Jade 1441, Turquoise 1442, Opal 1432, Sapphire 1443, Coral 1437
Phrase 9508...Maize 3010, Truffle 3050, Shale 3070, Sprout 3020, Marine 3030, Cayenne 3040,
 Poolside 3031

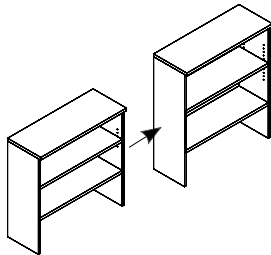

Upgrade Hutch Height from 36"H to 42"H

Model#	Depth	Width	Height	Weight	Cube	Price
MMUHH						\$237

Hutches: Doors or shelves do not change, bottom clearance increases by 6".
 Bookcase hutch: 12"H bottom clearance does not change.

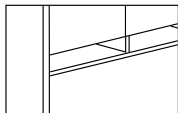

Hutch Mail Slots (Paper manager) (Decreases clearance under shelf by 5")

Model#	Depth	Width	Height	Weight	Cube	Price
MMHMS	12"	varies	4 3/4"	varies	varies	\$306

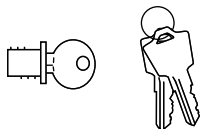

Face Lock for Hutch Doors

Model#	Depth	Width	Height	Weight	Cube	Price
MMFL						\$105

1 per set of 2 doors. Hutch with 4 doors takes 2 locks. Locks N/A for Glass Doors.

Upgrade and Accessories

STANDARD HANDLE OPTIONS

H3B is standard if none specified.



Crescent Black
(MMH3B)



Crescent Silver
(MMH3S)



Elliptical Black
(MMH5B)



Elliptical Silver
(MMH5S)



Crescent Textured Nickel
(MMH6)



Flared Nickel
(MMH7)



Bow Handle
(MMH8)



Curved Handle
(MMH9)



Bar Square Handle
(MMH10B)



Bar Square Handle
(MMH10S)



Bar Handle
(MMH14)

GROMMETS

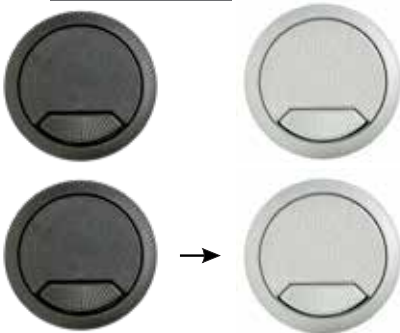

Grommet

Model#	Color	Depth	Width	Surface Hole Diameter	Price
MMGR234B	Black Plastic	3"	3"	2 3/4"	\$65
MMGR234S	Silver Plastic	3"	3"	2 3/4"	\$65

Grommet Color, Upgrade from Standard Black to Silver

Model#	Color	Depth	Width	Surface Hole Diameter	Price
MMUGR234S	Silver Plastic	3"	3"	2 3/4"	No Charge

GROMMETS LOCATION (Worksurface and modesty)

NOTE: While sitting at unit, grommet locations named from left to right.
For grommet location on tops and/or modesty panel specify left, center or right.
No grommets over pedestals.

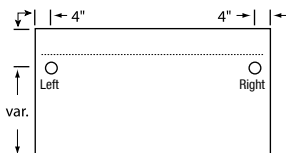

Desks

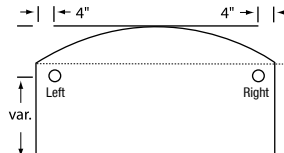

Desks

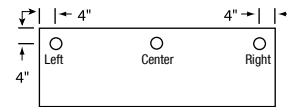

Credenza, Return,
Bridges

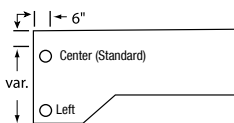

CompuCredenza

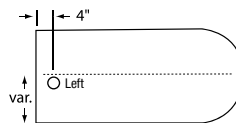

Bullets

Note: Black grommets are standard where shown on line drawings.

maverick complete

Accessories and upgrades

Specify standard handle selection at no charge, from H3B-H10B & H14.

For handles H11, H30 and APH1 charges apply, see below.

For handle option H3B-H10B & H14, add \$38/ea, add to Hutches & Wallmount Cabinets.



Crescent Handle, Metal - Black or Silver Finish

Model#	Hole Center	Width	Color	Price
☞ MMH3B	5"	5 3/4"	Black	N/C
☞ MMH3S	5"	5 3/4"	Silver	N/C

Elliptical Handle, Metal - Black or Silver Finish

Model#	Hole Center	Width	Color	Price
☞ MMH5B	5"	6 3/4"	Black	N/C
☞ MMH5S	5"	6 3/4"	Silver	N/C

Crescent Textured Nickel Handle, Metal - Silver Finish

Model#	Hole Center	Width	Price
☞ MMH6	5"	6 1/4"	N/C

Flared Nickel Handle, Metal - Silver Finish

Model#	Hole Center	Width	Price
☞ MMH7	5"	6 1/4"	N/C

Bow Handle, Silver Finish

Model#	Hole Center	Width	Price
☞ MMH8	5"	6 1/8"	N/C

Curved Handle, Silver Finish

Model#	Hole Center	Width	Price
☞ MMH9	5"	6 1/2"	N/C

Bar Square Handle, Black or Silver Finish

Model#	Hole Center	Width	Color	Price
☞ MMH10B	5"	5 3/8"	Black	N/C
☞ MMH10S	5"	5 3/8"	Silver	N/C

Bar Square Handle, Silver Finish

Model#	Hole Center	Width	Price
MMH11	11"	11 3/8"	\$83/ea.

MM H11 handles full upgrade charges apply.

Bar Handle, Silver Finish

Model#	Hole Center	Width	Price
☞ MMH14	11"	14"	N/C
MMH30*	27"	30"	\$83/ea.

MM H30* handles DO NOT fit on pedestal drawers or hutch doors. Full upgrade charges apply for MM H30.

Curved Edge Handle, Brushed Aluminum Finish

Model#	Hole Center	Width	Price
APH1	1 5/8"	7 7/8"	\$75/ea.

Extends ☞ lead time. Full upgrade charges apply.

When ordering APH1 handles for personal lateral files (1) lock is standard, locks file and lateral file only.

maverick complete

Accessories and Upgrades

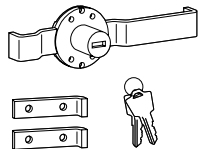

Pedestal Lock (Mounted on side of pedestal)

Model#	Description	Price
MMPL	Side pedestal lock	\$105

For **freestanding pedestals**, specify left or right side pedestal lock installation. Lock numbers are randomly assigned, key alike must be specify. No charge.

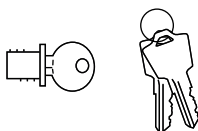

Face Lock

Model#	Description	Price
MMFL	Face lock for TFM doors or center drawers	\$105
MMFFL	Full face lock for pedestals	\$210

MMFL: 1 per set of 2 doors. Hutch with 4 doors requires 2 locks.
MMFFL: For B/F, F/F & BBF Pedestals.
Lock numbers (#101-115) are randomly assigned, key alike must be specify. No charge.

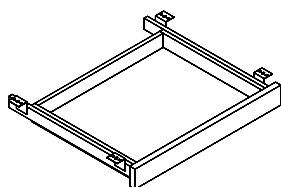

Center Drawer (9-ply birch wood drawer interior, specify front laminate color)

Model#	Depth	Width	Height	Weight	Cube	Price
MMCD	16"	21"	2 1/2"	12	.5	\$199

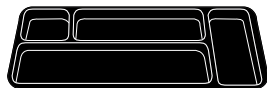

Box Drawer Convenience Tray, Black (Insets to box drawer)

Model#	Depth	Width	Height	Weight	Cube	Price
MMBPT	5 1/2"	12"	1"	1	.5	\$38

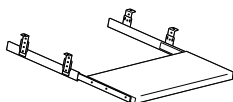

Keyboard Tray, Rollout (Specify laminate color)

Model#	Depth	Width	Height	Weight	Cube	Price
MMKB	16"	21"	3"	10	.5	\$181

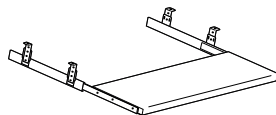

Oversize Keyboard Tray, Rollout (Specify laminate color)

Model#	Depth	Width	Height	Weight	Cube	Price
MMKBGL	16"	28"	3"	12	.5	\$268

maverick complete

Accessories and Upgrades

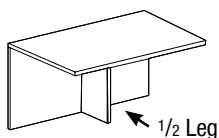

Half-Leg Support with Leveler (finished 3 sides)

Model#	Depth	Width	Height	Weight	Cube	Price
MMSPT	12"	1"	28"	11	3	\$151

Support leg can also be used to create freestanding returns. Specify freestanding and left or right 1/2" leg. Support leg is required if placing hutch on L-unit return. Add to long pieces for support.

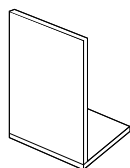

CPU Section (CPU1 for 3/4" Height Ped, CPU2 for Full Height Ped)

Model#	Depth	Width	Height	Weight	Cube	Price
MMCPU1	16"	10"	18 3/4"	15	2	\$151
MMCPU2	16"	10"	27 5/8"	18	3	\$191

Specify left or right mount. Add to desk, return or credenza.

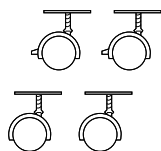

Casters, Set of Four (Two locking, two non-locking. For stands & HDC only)

Model#	Height	Price
MMCAS	2 1/2"	\$133

Height does not increase for printer and HDC.

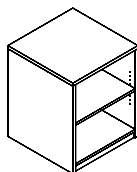

Printer Stand (Adjustable shelf, two back openings)

Model#	Depth	Width	Height	Weight	Cube	Price
MMPS2424	24"	24"	29"	65	10	\$779

For casters, add MMCAS \$123. Height does not increase.

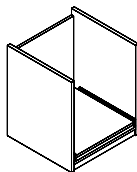

Printer Shelf with Roll-Out Shelf (Add to desk, return or credenza, each)

Model#	Depth	Width	Height	Weight	Cube	Price
MMPSS	22"	24"	28"	53	10	\$504

Rollout shelf is installed 1" clear from bottom.

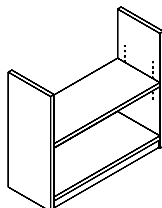

Bookcase Section (One adjustable shelf. Add to bridge or return shell)

Model#	Depth	Width	Height	Weight	Cube	Price
MMBCS	12"	32"	28"	varies	varies	\$351

No back panel.

Accessories and Upgrades

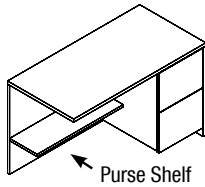

Purse Shelf (Add to desk, return or credenza)						
Model#	Depth	Width	Height	Weight	Cube	Price
MMPS	10"	varies	3/4"	varies	varies	\$151

Installed 17"H below.

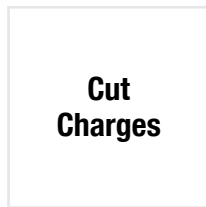

Standard Cuts and Reprogramming Charges (Extends lead time)		
Model#	Maverick Complete Only	Price
MMCUT1	1-Cut, Height or Width or Depth, 90° Cut on 90° Pieces	\$133
MMCUT2	2-Cuts, Two Dimensions, 90° Cuts on 90° Pieces	\$208
MMCUT3	Program charge on piece with cut other than 90°	\$208
MMCUT3GR	Program charge grommet removal (each)	\$72

For Maverick Complete cut charges items only. Cut charges vary by product, contact us to verify.



HPL Tops, with Standard Color 2MM Edge Band (Maverick standard colors only. Extends lead time)		
Model#	Standard Maverick Colors (Limited HPL Colors)	Price
MMHPLM	Matte High Pressure Laminate Top Only, 2MM Edge Band	15%

For Maverick HPL colors, see color availability chart.
For custom HPL color laminates, please submit quote. (15% does not apply).
Maverick does not guarantee delamination from sun exposure.

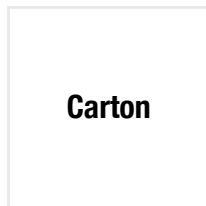

Cartoning Charges (Extends leadtime) Optional		
Model#		Price
MMCAR1	Bubble Wrap (Bubble and shrink wrap around product)	7%
MMCAR2	Packaging (Corner & edge protectors w/bubble & shrink wrap)	10%
MMCAR3	Full Cartoning (Corner & edge protectors w/bubble, shrink wrap & place in carton)	20%
MMCAR4	Pallet Cartoning (Corner & edge protectors w/bubble/shrink wrap, place in carton, strap to pallet)	25%

Cartoning is optional. Maverick product ships blanket wrapped.