

MAVERICK
OFFICE SOLUTIONS MADE IN THE U.S.A

**adapt
series**







AD1 | Majestic White • Cappuccino • H10B Handles • Tackboard Fabric Metro 3077 • Skyscraper 022

QTY	MODEL NO.	DESCRIPTION	UNIT	PRICE
1	ADSPBR7248	Shared Spine Panel, Right 72"W x 1"D x 48"H	\$634	\$634
2	ADSPFR7248	Shared Spine Panel, Right 72"W x 1"D x 48"H	\$634	\$1,268
1	ADPPI4948	Privacy End Panel 49 ¹ / ₈ "W x 1"D x 48"H	\$477	\$477
3	ADMPBL7248	Modesty Panel End, Left 72"W x 1"D x 48"H	\$634	\$1,902
3	ADMPBR7248	Modesty Panel End, Right 72"W x 1"D x 48"H	\$634	\$1,902
6	ADRW2472	Rectangular Worksurface 72"W x 24"D x 48"H	\$390	\$2,340
6	ADLEGA2428	End Panel 72"W x 1"D x 48"H	\$200	\$1,200
6	MMSB72	External Stabilizer Bar 56"	\$181	\$1,086
3	ADSBL2470L	Low Credenza Single Box/Lateral Left, 70 ⁷ / ₈ "W x 24"D x 22"H	\$2,130	\$6,390
3	ADSBL2470R	Low Credenza Single Box/Lateral Right, 70 ⁷ / ₈ "W x 24"D x 22"H	\$2,130	\$6,390
9	ADPSF7208	Privacy Screen Frosted Acrylic 65"W x 3 ³ / ₈ "D x 8"H	\$607	\$5,463
1	APESG72	Hardwire Electrical Starter Cable 72"	\$296	\$296
6	APSSPB4	Single Sided Power Box w/ 4 Outlets	\$231	\$1,386
4	APDCE72	Daisy Chain Electrical Cable 64"	\$328	\$1,312
1	APDCE36	Daisy Chain Electrical Cable 28"	\$241	\$241
6	ADWM44	Aluminum Wire Management Trough, Silver 44"W x 2 ¹ / ₂ "D x 3 ¹ / ₂ "H	\$160	\$960
5	MMGR23B	Plastic Grommet, Black (for electricals, placement is required)	\$73	\$365
6	MMTKBD66	Tackboard 66"W x 1 ¹ / ₂ "D x 14 ¹ / ₄ "H	\$824	\$4,944
			Total	38,556

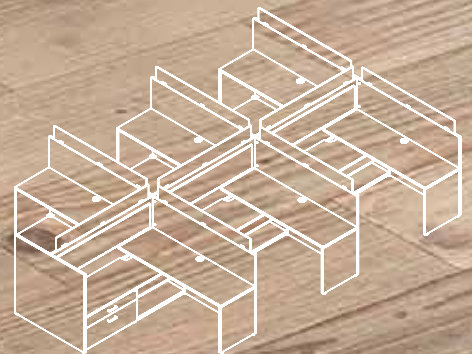



AD2 | Majestic White • Greystone • Apron Metal Legs Black • H10B Handles • Tackboard Fabric Phrase 9508 • Shale 3070

QTY	MODEL NO.	DESCRIPTION	UNIT	PRICE
1	ADSPBR7248	Shared Spine Panel, Right 72"W x 1"D x 48"H	\$634	\$634
2	ADSPFR7248	Shared Spine Panel, Right 72"W x 1"D x 48"H	\$634	\$1,268
1	ADPPI4948	Privacy End Panel 49 1/8"W x 1"D x 48"H	\$477	\$477
3	ADMPLB7248	Modesty Panel End, Left 72"W x 1"D x 48"H	\$634	\$1,902
3	ADMPLR7248	Modesty Panel End, Right 72"W x 1"D x 48"H	\$634	\$1,902
6	ADRW2472	Rectangular Worksurface 72"W x 24"D x 48"H	\$390	\$2,340
6	APOAL24	Apron Frame Leg, Silver 24"D x 28"H	\$614	\$3,684
6	MMSB72	External Stabilizer Bar 56"	\$181	\$1,086
3	ADSBL2470L	Low Credenza Single Box /Lateral Left, 70 7/8"W x 24"D x 22"H	\$2,130	\$6,390
3	ADSBL2470R	Low Credenza Single Box /Lateral Right, 70 7/8"W x 24"D x 22"H	\$2,130	\$6,390
9	ADPSF7208	Privacy Screen Frosted Acrylic 65"W x 3/8"D x 8"H	\$607	\$5,463
1	APESC72	Hardwire Electrical Starter Cable 72"	\$296	\$296
6	APSSPB4	Single Sided Power Box w/ 4 Outlets	\$231	\$1,386
4	APDCE72	Daisy Chain Electrical Cable 64"	\$328	\$1,312
1	APDCE36	Daisy Chain Electrical Cable 28"	\$241	\$241
6	ADWM44	Aluminum Wire Management Trough, Silver 44"W x 2 1/2"D x 3 1/2"H	\$160	\$960
6	ADAWT42	Aluminum Wall Track, Silver 42"W x 1 1/2"D x 4 3/4"H	\$139	\$834
12	ADLPTS	Paper Tray Letter Size, Silver 3 1/8"W x 9 7/16"D x 7/8"H	\$76	\$912
6	ADPBS	Pencil Box, Silver 3 1/8"W x 2 9/16"D x 3 9/16"H	\$45	\$270
5	MMGR23B	Plastic Grommet, Black (for electricals, placement is required)	\$73	\$365
6	MMTKBD66	Tackboard 66"W x 1 1/2"D x 14 1/4"H	\$824	\$4,944

Total \$43,056

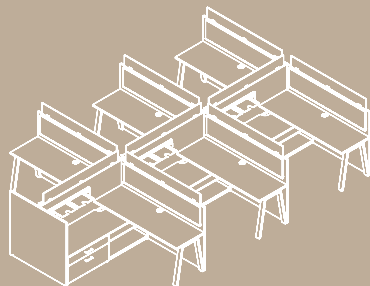



AD5

Majestic White • Desert Walnut • H11 Handles* • Frosted Acrylic Privacy Screens •
Tackboard & Cushion Fabric: Phrase 9508 • Sprout 3020 *upcharges apply

QTY	MODEL NO.	DESCRIPTION	UNIT	PRICE
1	ADSPBR7248	Shared Spine Panel, Right 72"W x 1"D x 48"H	\$634	\$634
1	ADSPBL7248	Shared Spine Panel, Left 72"W x 1"D x 48"H	\$634	\$634
4	ADMPPA7248	Modesty Panel, Left 72"W x 1"D x 48"H	\$634	\$2,536
2	ADEPAL3148	End Panel, Left 31"W x 1"D x 48"H	\$355	\$710
2	ADEPAR3148	End Panel, Right 31"W x 1"D x 48"H	\$355	\$710
4	ADRW2471	Rectangular Worksurface 71"W x 24"D x 1"H	\$387	\$1,548
4	MMLEGAHE24W3	Height Adjustable Electrical Base 22"D, White	\$1,558	\$6,232
2	ADSBL2470L	Low Credenza Single Box/Lateral Left, 70 ⁷ / ₈ "W x 24"D x 22"H	\$2,130	\$4,260
2	ADSBL2470R	Low Credenza Single Box/Lateral Right, 70 ⁷ / ₈ "W x 24"D x 22"H	\$2,130	\$4,260
2	ADPSF7208	Privacy Screen Frosted Acrylic 65"W x 3 ³ / ₈ "D x 8"H	\$607	\$1,214
1	APESC72	Hardwire Electrical Starter Cable 72"	\$296	\$296
4	APSSPB4	Single Sided Power Box w/ 4 Outlets	\$231	\$924
2	APDCE106	Daisy Chain Electrical Cable 98"	\$398	\$796
1	APDCE36	Daisy Chain Electrical Cable 28"	\$241	\$241
4	ADWM44	Aluminum Wire Management Trough, Silver 44"W x 2 ¹ / ₂ "D x 3 ¹ / ₂ "H	\$160	\$640
4	MMTKBD42	Tackboard 42"W x 1 ¹ / ₂ "D x 14 ¹ / ₄ "H	\$634	\$2,536
4	APCUH2430	Cushion 30"W x 23"D x 1"H For Low Credenza	\$398	\$1,592
1	MMGR23S	Plastic Grommet, Silver (for electricals, placement is required)	\$73	\$73
Total			\$29,836	

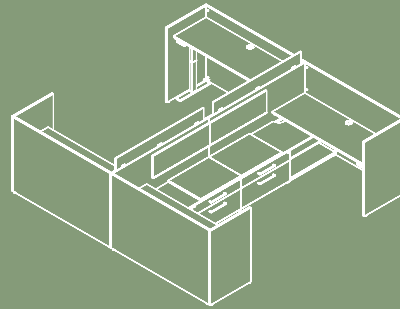



AD7 | Majestic White • Cappuccino • H10B Handles • Metal D-Legs White

QTY	MODEL NO.	DESCRIPTION	UNIT	PRICE
1	ADPPK7248	Privacy Panel 72"W x 1"D x 48"H	\$634	\$634
2	ADRW2472	Rectangular Worksurface 72"W x 24"D x 1"H	\$390	\$780
4	APODL24	D-Leg 24"D x 28"H, White	\$416	\$1,664
2	MMSB72	External Stabilizer Bar 56"	\$181	\$362
2	MCPEDAX20	Mobile Box /File Pedestal 16"W x 19"D x 22"H	\$1,033	\$2,066
1	ADPSF7208	Privacy Screen Frosted Acrylic 65"W x 3/8"D x 8"H	\$607	\$607
1	APESC72	Hardwire Electrical Starter Cable 72"	\$296	\$296
2	APSSPB4	Single Sided Power Box w/ 4 Outlets	\$231	\$462
1	APDCE66	Daisy Chain Electrical Cable 58"	\$317	\$317
2	ADWM44	Aluminum Wire Management Trough, Silver 44"W x 2 1/2"D x 3 1/2"H	\$160	\$320
1	MMGR23B	Plastic Grommet, Black (for electricals, placement is required)	\$73	\$73
Total			\$7,581	

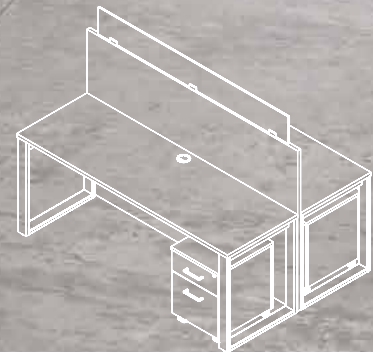



AD11 | Majestic White • Greystone • H10S Handles

QTY	MODEL NO.	DESCRIPTION	UNIT	PRICE
1	ADN307248	Privacy Desk Shell 72"W x 30"D x 48"H	\$1,512	\$1,512
1	ADSNR307148	Shared Privacy Right Desk Shell 71"W x 30"D x 48"H	\$1,225	\$1,225
1	ADRND474848	Privacy Return Shell, Double Sided, 48"W x 47"D x 48"H	\$1,356	\$1,356
4	ADPEDBBF18	Mounting Box/Box/File Pedestal 15 ³ / ₄ "W x 18 ¹ / ₂ "D x 28 ¹ / ₈ "H	\$1,017	\$4,068
1	APESC72	Hardwire Electrical Starter Cable 72"	\$296	\$296
2	APSSPB4	Single Sided Power Box w/ 4 Outlets	\$231	\$462
1	APDCE36	Daisy Chain Electrical Cable 28"	\$241	\$241
4	ADWM44	Aluminum Wire Management Trough, Silver 44"W x 2 ¹ / ₂ "D x 3 ¹ / ₂ "H	\$160	\$320
1	MMGR23S	Plastic Grommet, Silver (for electricals, placement is required)	\$73	\$73
			Total	\$9,553

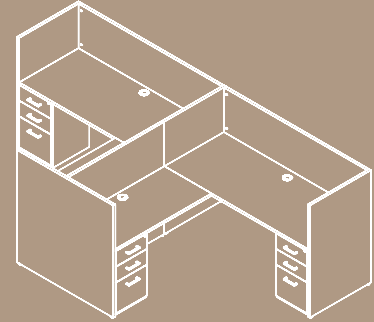

AD12 | Greige • Amber • H10S Handles

QTY	MODEL NO.	DESCRIPTION	UNIT	PRICE
2	ADN307248	Privacy Desk Shell 72"W x 30"D x 48"H	\$1,512	\$3,024
1	ADBR244848	Privacy Bridge 48"W x 24"D x 48"H	\$871	\$871
1	ADRNL244848	Privacy Return Shell Left, 48"W x 24"D x 48"H	\$945	\$945
2	ADPEDBBF18	Mounting Box/Box/File Pedestal 15 ³ / ₄ "W x 18 ¹ / ₂ "D x 28 ¹ / ₈ "H	\$1,017	\$2,034
2	ADPEDFF18	Mounting File/File Pedestal 15 ³ / ₄ "W x 18 ¹ / ₂ "D x 28 ¹ / ₈ "H	\$900	\$1,800
1	APESC72	Hardwire Electrical Starter Cable 72"	\$296	\$296
2	APSSPB4	Single Sided Power Box w/ 4 Outlets	\$231	\$462
1	APDCE78	Daisy Chain Electrical Cable 70"	\$329	\$329
2	ADWM44	Aluminum Wire Management Trough, Silver 44"W x 2 ¹ / ₂ "D x 3 ¹ / ₂ "H	\$160	\$320
1	MMGR23S	Plastic Grommet, Silver (for electricals, placement is required)	\$73	\$73
Total			\$10,154	

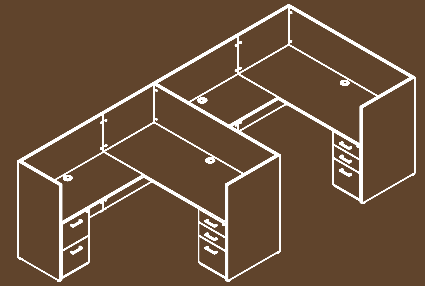





AD4 | Majestic White • Driftwood • H11 Handles* • Frosted Acrylic Privacy Screens *upcharges apply

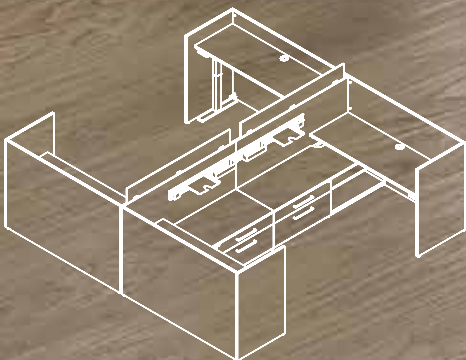

QTY	MODEL NO.	DESCRIPTION	UNIT	PRICE
1	ADSPBR7248	Shared Spine Panel, Right 72"W x 1"D x 48"H	\$634	\$634
1	ADSPBL7248	Shared Spine Panel, Left 72"W x 1"D x 48"H	\$634	\$634
4	ADMPBA7248	Modesty Panel 72"W x 1"D x 48"H	\$634	\$2,536
2	ADEPAL3148	End Panel, Left 31"W x 1"D x 48"H	\$355	\$710
2	ADEPAR3148	End Panel, Right 31"W x 1"D x 48"H	\$355	\$710
4	ADRW2471	Rectangular Worksurface 71"W x 24"D x 1"H	\$387	\$1,548
4	MMLEGAHE24S3	Height Adjustable Electrical Base 22"D, Silver	\$1,558	\$6,232
2	ADSBL2470L	Low Credenza Single Box/Lateral Left, 70 ⁷ / ₈ "W x 24"D x 22"H	\$2,130	\$4,260
2	ADSBL2470R	Low Credenza Single Box/Lateral Right, 70 ⁷ / ₈ "W x 24"D x 22"H	\$2,130	\$4,260
2	ADPSF7208	Privacy Screen Frosted Acrylic 65"W x 3 ³ / ₈ "D x 8"H	\$607	\$1,214
1	APESC72	Hardwire Electrical Starter Cable 72"	\$296	\$296
6	APSSPB4	Single Sided Power Box w/ 4 Outlets	\$231	\$1,386
2	APDCE106	Daisy Chain Electrical Cable 98"	\$398	\$796
1	APDCE36	Daisy Chain Electrical Cable 28"	\$241	\$241
6	ADWM44	Aluminum Wire Management Trough, Silver 44"W x 2 ¹ / ₂ "D x 3 ¹ / ₂ "H	\$160	\$960
4	ADAWT42	Aluminum Wall Track, Silver 42"W x 1 ¹ / ₂ "D x 4 ³ / ₄ "H	\$139	\$556
4	ADLPTS	Paper Tray Letter Size, Silver 3 ¹ / ₈ "W x 9 ⁷ / ₁₆ "D x 7 ⁷ / ₈ "H	\$76	\$304
4	ADPBS	Pencil Box, Silver 3 ¹ / ₈ "W x 2 ⁹ / ₁₆ "D x 3 ⁹ / ₁₆ "H	\$45	\$180
4	ADLPHS	Letter Paper Hanger, Silver 12 ³ / ₈ "W x 2 ¹³ / ₁₆ "D x 4 ¹ / ₁₆ "H	\$45	\$180
1	MMGR23B	Plastic Grommet, Black (for electricals, placement is required)	\$73	\$73

Total \$27,710

QTY	MODEL NO.	DESCRIPTION	UNIT	PRICE
1	ADSPBR7248	Shared Spine Panel, Right 72"W x 1"D x 48"H	\$634	\$634
1	ADSPBL7248	Shared Spine Panel, Left 72"W x 1"D x 48"H	\$634	\$634
2	ADMPBL3648	Modesty Panel End, Left 36"W x 1"D x 48"H	\$389	\$778
2	ADMPBR3648	Modesty Panel End, Right 36"W x 1"D x 48"H	\$389	\$778
4	ADRW2472	Rectangular Worksurface 72"W x 24"D x 1"H	\$390	\$1,560
4	GROTL24	Tapered Metal Leg 24"D x 28"H	\$676	\$2,704
4	MMSB72	External Stabilizer Bar 56"	\$181	\$724
2	ADSBL2470L	Low Credenza Single Box/Lateral Left, 70 ⁷ / ₈ "W x 24"D x 22"H	\$2,130	\$4,260
2	ADSBL2470R	Low Credenza Single Box/Lateral Right, 70 ⁷ / ₈ "W x 24"D x 22"H	\$2,130	\$4,260
2	ADPSF7208	Privacy Screen Frosted Acrylic 65"W x 3 ³ / ₈ "D x 8"H	\$607	\$1,214
1	APESC72	Hardwire Electrical Starter Cable 72"	\$296	\$296
6	APSSPB4	Single Sided Power Box w/ 4 Outlets	\$231	\$1,386
2	APDCE106	Daisy Chain Electrical Cable 98"	\$398	\$796
1	APDCE36	Daisy Chain Electrical Cable 28"	\$241	\$241
6	ADWM44	Aluminum Wire Management Trough, Silver 44"W x 2 ¹ / ₂ "D x 3 ¹ / ₂ "H	\$160	\$960
1	MMGR23B	Plastic Grommet, Black (for electricals, placement is required)	\$73	\$73
4	MMTKBD66	Tackboard 66"W x 1 ¹ / ₂ "D x 14 ¹ / ₄ "H	\$824	\$3,296
Total			\$24,594	

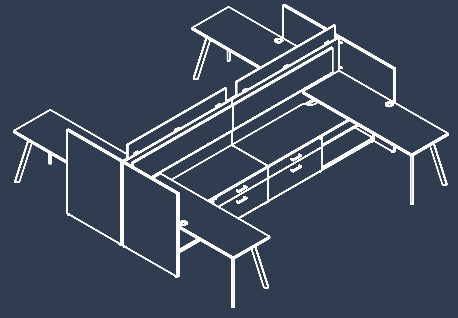

AD9 | Greige • Ash • H10S Handles

QTY	MODEL NO.	DESCRIPTION	UNIT	PRICE
1	ADN307248	Privacy Desk Shell 72"W x 30"D x 48"H	\$1,512	\$1,512
1	ADBR244848	Privacy Bridge 48"W x 24"D x 48"H	\$871	\$871
1	ADN247248	Modesty Panel, Left 72"W x 1"D x 48"H	\$1,383	\$1,383
1	ADPEDBBF18	Mounting Box/Box/File Pedestal 15 ³ / ₄ "W x 18 ¹ / ₂ "D x 28 ¹ / ₈ "H	\$1,017	\$1,017
1	ADPEDLF1835	Mounting Lateral File 2-Drawer Pedestal 18 ¹ / ₂ "D x 35 ⁷ / ₈ "W	\$1,558	\$1,558
1	APESC72	Hardwire Electrical Starter Cable 72"	\$296	\$296
1	APSSPB4	Single Sided Power Box w/ 4 Outlets	\$231	\$231
1	ADWM44	Aluminum Wire Management Trough, Silver 44"W x 2 ¹ / ₂ "D x 3 ¹ / ₂ "H	\$160	\$160
1	MMGR23S	Plastic Grommet, Silver (for electricals, placement is required)	\$73	\$73
Total			\$7,101	

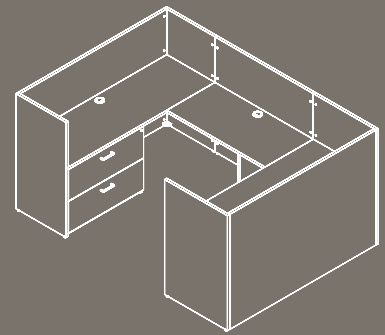



AD6 | Majestic White • Beachwood

QTY	MODEL NO.	DESCRIPTION	UNIT	PRICE
1	ADSPBR4848	Shared Spine Panel, Right 48"W x 1"D x 48"H	\$471	\$471
2	ADSPFR4848	Shared Spine Panel, Right 48"W x 1"D x 48"H	\$471	\$942
3	ADMPBL3048	Modesty Panel End, Left 30"W x 1"D x 48"H	\$348	\$1,044
3	ADMPBR3048	Modesty Panel End, Right 30"W x 1"D x 48"H	\$348	\$1,044
1	ADPPI6148	Privacy End Panel 61 ¹ / ₁₆ "W x 1"D x 48"H	\$559	\$559
6	ADRW2447	Rectangular Worksurface 47"W x 24"D x 1"H	\$302	\$1,812
1	APESC72	Hardwire Electrical Starter Cable 72"	\$296	\$296
6	APSSPB4	Single Sided Power Box w/ 4 Outlets	\$231	\$1,386
5	APDCE48	Daisy Chain Electrical Cable 40"	\$266	\$1,330
6	ADWM32	Aluminum Wire Management Trough, Silver 32"W x 2 ¹ / ₂ "D x 3 ¹ / ₂ "H	\$134	\$804
5	MMGR23S	Plastic Grommet, Silver (for electricals, placement is required)	\$73	\$365
			Total	\$10,053

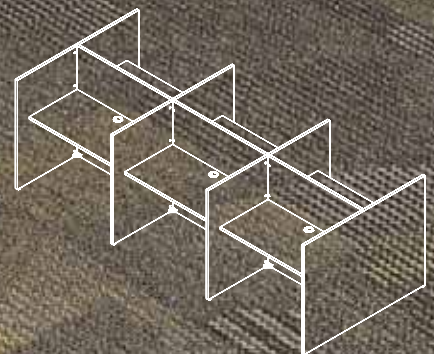







AD8 Greystone • H10S Handles

QTY	MODEL NO.	DESCRIPTION	UNIT	PRICE
1	ADN307248	Privacy Desk Shell 72"W x 30"D x 48"H	\$1,512	\$1,512
1	ADRNL244848	Privacy Return Shell, Left 48"W x 24"D x 48"H	\$945	\$945
1	ADPEDBBF18	Box/Box/File Pedestal 15 ³ / ₄ "W x 18 ¹ / ₂ "D x 28 ¹ / ₈ "H	\$1,017	\$1,017
1	ADPEDFF18	Mounting File/File Pedestal 15 ³ / ₄ "W x 18 ¹ / ₂ "D x 28 ¹ / ₈ "H	\$900	\$900
1	APESC72	Hardwire Electrical Starter Cable 72"	\$296	\$296
1	APSSPB4	Single Sided Power Box w/ 4 Outlets	\$231	\$231
1	ADWM44	Aluminum Wire Management Trough, Silver 44"W x 2 ¹ / ₂ "D x 3 ¹ / ₂ "H	\$160	\$160
1	MMGR23S	Plastic Grommet, Silver (for electricals, placement is required)	\$73	\$73
Total			\$5,134	

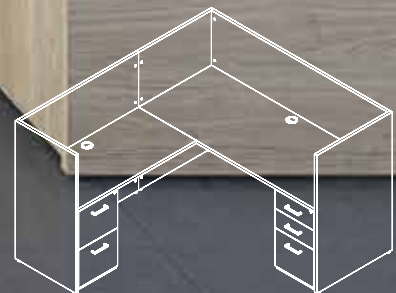



AD13 | Greige • Beachwood • H10S Handles

QTY	MODEL NO.	DESCRIPTION	UNIT	PRICE
1	ADSPAL7248	Spine End Panel Left, 72"W x 1"D x 48"H	\$634	\$634
1	ADSPEL7248	Spine End Panel Left, 72"W x 1"D x 48"H	\$634	\$634
2	ADMPA7248	Modesty Panel 72"W x 1"D x 48"H	\$634	\$1,268
2	ADEPAR3148	End Panel Right, 31"W x 1"D x 48"H	\$355	\$710
1	ADPPJL2648	Privacy End Panel Left, 26"W x 1"D x 48"H	\$321	\$321
2	ADRW2471	Rectangular Worksurface 71"W x 24"D x 1"H	\$387	\$774
2	ADRW2446	Rectangular Worksurface 46"W x 24"D x 1"H	\$298	\$596
2	MMLEGAHEL24W	L-Shape Electrical Height Adjustable Base 22", White	\$2,704	\$5,408
2	MCPEDA x 20	Mounting Mobile Box/File Pedestal 16"W x 19"D x 22"H	\$1,033	\$2,066
1	APESC72	Hardwire Electrical Starter Cable 72"	\$296	\$296
2	APSSPB4	Single Sided Power Box w/ 4 Outlets	\$231	\$462
1	APDCE78	Daisy Chain Electrical Cable 70"	\$329	\$329
2	ADWM44	Aluminum Wire Management Trough, Silver 2 1/2"D x 44"W x 3 1/2"H	\$160	\$320
1	MMGR23S	Plastic Grommet, Silver (for electricals, placement is required)	\$73	\$73
2	ADPSF7208	Frosted Acrylic Privacy Screen 65"W x 3 3/8"D x 8"H	\$607	\$1,214
			Total	\$15,105

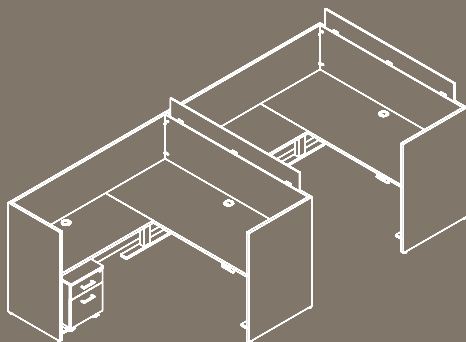



AD10 | Majestic White • Amber • H10B Handles • Tackboard Fabric Achorage 2335 • Onyx 2016

QTY	MODEL NO.	DESCRIPTION	UNIT	PRICE
2	ADCDNQ7248 9R	Privacy Compu Corner Desk Shell Right, 30/24" x 42" x 72" x 48"H	\$1,796	\$3,592
2	ADSCDNQ7148 9L	Shared Privacy Compu Corner Desk Shell Left, 30/24" x 42" x 71" x 48"H	\$1,433	\$2,866
1	ADBRD474848	Privacy Bridge Double Sided, 48"W x 47"D x 48"H	\$1,252	\$1,252
1	ADRND474848	Privacy Return Shell, Double Sided, 48"W x 47"D x 48"H	\$1,356	\$1,356
4	ADPEDPLF1830	Mounting Personal Lateral File Pedestal, 30 ¹¹ / ₁₆ "W x 18 ¹ / ₂ "D x 28 ¹ / ₈ "H	\$1,804	\$7,216
1	APESC72	Hardwire Electrical Starter Cable 72"	\$296	\$296
4	APSSPB4	Single Sided Power Box w/ 4 Outlets	\$231	\$924
1	APDCE48	Daisy Chain Electrical Cable 40"	\$266	\$266
2	APDCE94	Daisy Chain Electrical Cable 86"	\$369	\$738
4	ADWM44	Aluminum Wire Management Trough, Silver 44"W x 2 ¹ / ₂ "D x 3 ¹ / ₂ "H	\$160	\$640
3	MMGR23B	Plastic Grommet, Black (for electricals, placement is required)	\$73	\$219
Total			\$19,365	

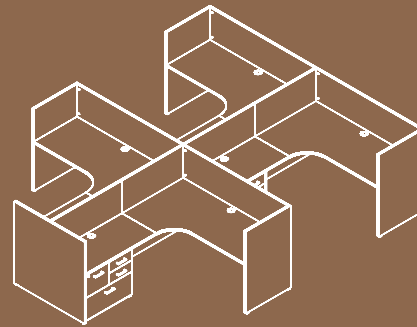

Product Specifications

- 20 standard colors are available on tops and chassis. Two colors may be specified at no charge.

Top / Worksurfaces

- 1" TFM (Thermally Fused Melamine) on industrial quality (45 lb.) particleboard. (Except ADSBL____L and ADSBL____R are 3/4").
- 2mm thermally-fused PVC edge banding.
- Woodgrain direction on tops runs horizontal.

Chassis Construction

- TFM chassis fastened by screws, steel brackets, and/or concealed fasteners.
- 1" Thick chassis on desk, bridge, and return shells.
- 3/4" Thick chassis on pedestals and low credenzas.
- Visible edges are edged with 2mm thermally-fused PVC edge banding.
- Adjustable leveling glides are provided on all non mobile units.
- Woodgrain direction is horizontal on all surfaces except pedestal and low credenza sides.

Drawer Interiors

- 9-ply Birch wood drawers.

Drawer Suspension, Construction and Doors

- Box drawers have full-extension, progressive-action slides with precision steel ball bearings.
- Heavy-duty file rods in file drawers
- H3B handles and locks are standard.
- Overlay drawer fronts are standard.
- All file drawers file legal-size side to side.
- Each pedestal and low credenza containing a box drawer is provided with one box drawer convenience tray.
- File drawer construction accomodates hanging files not stacked material on drawer bottom.

Cord Management

- Standard grommets centered on the worksurfaces.
- Refer to Maverick pricer for additional grommets and options.

Locks

- Face locks are standard on all pedestals and low credenzas where specified.
- Black or silver, removable cores are standard for all locks.
- Lock numbers (#101-115) are randomly assigned to all, except units consisting with two locks will be keyed alike.
- Key alike may be specified at no charge.
- Master keys are available for purchase. Refer to Maverick Series pricer.

Custom Sizes Are Available
For custom quotes, email our Design Team

Maverick West
design@maverickdesk.com

Maverick East
designeast@maverickdesk.com

Note: Dimensions assigned in this price list are nominal. If exact measurements are required, the requirement must be specified in the order and specifically acknowledged by Maverick. Maverick reserves the right to change construction details and standards without notification, if necessary.

Line Drawings shown are a resemblance to finished product. Product designs may vary. Discounts are different between factories. Colors may vary between factories.

Specification Options and Requirements

Order	Options
<ul style="list-style-type: none"> • Model Number • Top • Top Edge • Base • Drawer/Door • Handle • Lock • Grommet • Lead Time 	<ul style="list-style-type: none"> • See list. • Select standard color. • Select standard color, default will match top color. • Select standard color, default will match top color. Edge will match base color. • Select standard color, default will match base color. Edge will match drawer/door color. • Select standard H3S–H10 & H14, default will be H3B black. • Keyed random unless specified key alike. Lock core color will match handle color. • Black is default. Silver may be specified at no upcharge. • 20 days.

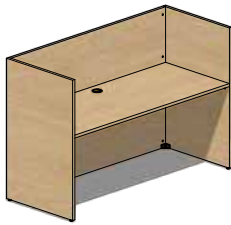

Privacy Desk Shells

Privacy Desk Shell (Grommet top center)

Model#	Depth	Width	Height	Weight	Cube	Price
ADN244848	24"	48"	48"	150	32	\$1,157
ADN246048	24"	60"	48"	173	40	\$1,270
ADN246648	24"	66"	48"	185	44	\$1,326
ADN247248	24"	72"	48"	196	48	\$1,383
ADN304848	30"	48"	48"	173	40	\$1,269
ADN306048	30"	60"	48"	198	50	\$1,390
ADN306648	30"	66"	48"	210	55	\$1,451
ADN307248	30"	72"	48"	223	60	\$1,512

Specify if for standalone use or return/bridge connection side and size. Ships assembled.

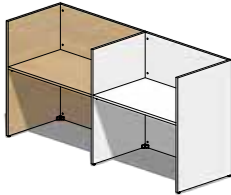

Shared Privacy Left Desk Shell (Grommet top center)

Model#	Depth	Width	Height	Weight	Cube	Price
ADSNL244748	24"	47"	48"	119	31	\$907
ADSNL245948	24"	59"	48"	142	39	\$1,020
ADSNL246548	24"	65"	48"	154	43	\$1,076
ADSNL247148	24"	71"	48"	165	47	\$1,133
ADSNL304748	30"	47"	48"	134	39	\$981
ADSNL305948	30"	59"	48"	159	49	\$1,103
ADSNL306548	30"	65"	48"	172	54	\$1,164
ADSNL307148	30"	71"	48"	184	59	\$1,225

Connection to user left side of Privacy Desk shell. Ships assembled.

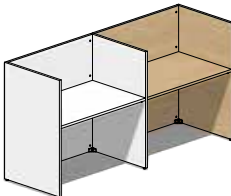

Shared Privacy Right Desk Shell (Grommet top center)

Model#	Depth	Width	Height	Weight	Cube	Price
ADSNR244748	24"	47"	48"	119	31	\$907
ADSNR245948	24"	59"	48"	142	39	\$1,020
ADSNR246548	24"	65"	48"	154	43	\$1,076
ADSNR247148	24"	71"	48"	165	47	\$1,133
ADSNR304748	30"	47"	48"	134	39	\$981
ADSNR305948	30"	59"	48"	159	49	\$1,103
ADSNR306548	30"	65"	48"	172	54	\$1,164
ADSNR307148	30"	71"	48"	184	59	\$1,225

Connection to user right side of Privacy Desk shell. Ships assembled.

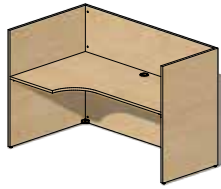

Privacy Desk Shells

Privacy Compu-Corner Desk Shell, Curved, Left (Grommet top center)

Model#	End/Return	Corner	Width	Height	Weight	Cube	Price
ADCDNQ7248 4L	24/24"	36"	72"	48"	219	72	\$1,666
ADCDNQ7248 9L	30/24"	42"	72"	48"	245	84	\$1,796

Specify if standalone or for return/bridge connection. Ships assembled.

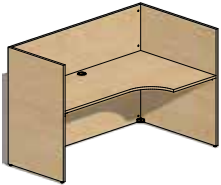

Privacy Compu-Corner Desk Shell, Curved, Right (Grommet top center)

Model#	End/Return	Corner	Width	Height	Weight	Cube	Price
ADCDNQ7248 4R	24/24"	36"	72"	48"	219	72	\$1,666
ADCDNQ7248 9R	30/24"	42"	72"	48"	245	84	\$1,796

Specify if standalone or for return/bridge connection. Ships assembled.

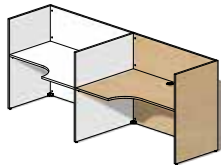

Shared Privacy Compu-Corner Desk Shell, Curved, Left (Grommet top center)

Model#	End/Return	Corner	Width	Height	Weight	Cube	Price
ADSCDNQ7148 4L	24/24"	36"	71"	48"	172	71	\$1,341
ADSCDNQ7148 9L	30/24"	42"	71"	48"	191	83	\$1,433

Connection to user right side of privacy compu-corner desk shell. Ships assembled.

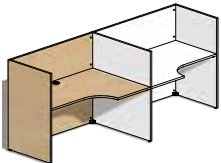

Shared Privacy Compu-Corner Desk Shell, Curved, Right (Grommet top center)

Model#	End/Return	Corner	Width	Height	Weight	Cube	Price
ADSCDNQ7148 4R	24/24"	36"	71"	48"	172	71	\$1,341
ADSCDNQ7148 9R	30/24"	42"	71"	48"	191	83	\$1,433

Connection to user left side of privacy compu-corner desk shell. Ships disassembled.

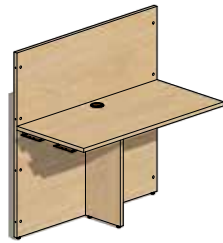

Privacy Bridges

Privacy Bridge (Grommet top center)

Model#	Depth	Width	Height	Weight	Cube	Price
ADBR204248	20"	42"	48"	85	23	\$793
ADBR204848	20"	48"	48"	96	27	\$846
ADBR244248	24"	42"	48"	90	28	\$815
ADBR244848	24"	48"	48"	101	32	\$871

12"D support leg with notchout included. Ships assembled.

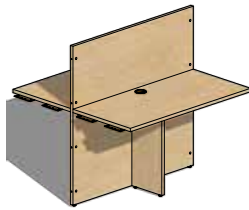

Privacy Bridge Double Sided (Grommet top center)

Model#	Depth	Width	Height	Weight	Cube	Price
ADBRD394248	39"	42"	48"	116	46	\$1,133
ADBRD394848	39"	48"	48"	130	52	\$1,202
ADBRD474248	47"	42"	48"	125	55	\$1,177
ADBRD474848	47"	48"	48"	140	63	\$1,252

(2) 12"D support legs with notchout included. Ships assembled.

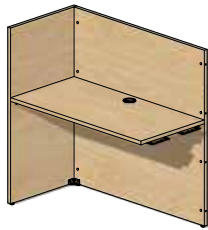

Privacy Returns

Privacy Return Shell, Left (Grommet top center)

Model#	Depth	Width	Height	Weight	Cube	Price
ADRNL204248	20"	42"	48"	100	23	\$842
ADRNL204848	20"	48"	48"	111	27	\$895
ADRNL244248	24"	42"	48"	110	28	\$888
ADRNL244848	24"	48"	48"	121	32	\$945

Ships assembled.

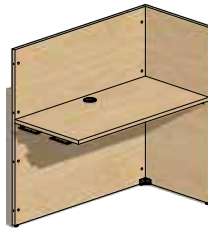

Privacy Return Shell, Right (Grommet top center)

Model#	Depth	Width	Height	Weight	Cube	Price
ADRNR204248	20"	42"	48"	100	23	\$842
ADRNR204848	20"	48"	48"	111	27	\$895
ADRNR244248	24"	42"	48"	110	28	\$888
ADRNR244848	24"	48"	48"	121	32	\$945

Ships assembled.

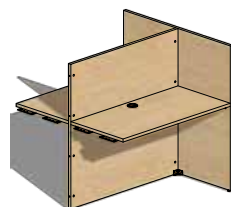

Privacy Return Shell, Double Sided (Grommet top center)

Model#	Depth	Width	Height	Weight	Cube	Price
ADRND394248	39"	42"	48"	146	46	\$1,188
ADRND394848	39"	48"	48"	160	52	\$1,256
ADRND474248	47"	42"	48"	165	55	\$1,281
ADRND474848	47"	48"	48"	180	63	\$1,356

Ships assembled.

Privacy Panels

Note: Privacy panels must be secured to a combination of worksurfaces, pedestals and low credenzas for stability.

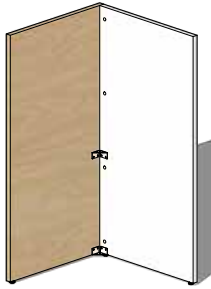

End Panel, Left

Model#	Depth	Width	Height	Weight	Cube	Price
ADEPAL2548	1"	25"	48"	33	1	\$314
ADEPAL2648	1"	26"	48"	34	1	\$321
ADEPAL3148	1"	31"	48"	40	1	\$355
ADEPAL3248	1"	32"	48"	42	1	\$362
ADEPAL6048	1"	60"	48"	78	2	\$552
ADEPAL6648	1"	66"	48"	86	2	\$593
ADEPAL7248	1"	72"	48"	93	2	\$634
ADEPAL7848	1"	78"	48"	101	2	\$675

Ships with hardware and pre-drilled connection to modesty panel on user right.

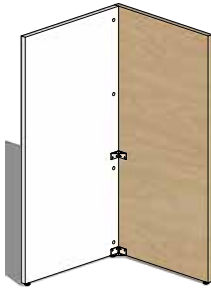

End Panel, Right

Model#	Depth	Width	Height	Weight	Cube	Price
ADEPAR2548	1"	25"	48"	33	1	\$314
ADEPAR2648	1"	26"	48"	34	1	\$321
ADEPAR3148	1"	31"	48"	40	1	\$355
ADEPAR3248	1"	32"	48"	42	1	\$362
ADEPAR6048	1"	60"	48"	78	2	\$552
ADEPAR6648	1"	66"	48"	86	2	\$593
ADEPAR7248	1"	72"	48"	93	2	\$634
ADEPAR7848	1"	78"	48"	101	2	\$675

Ships with hardware and pre-drilled connection to modesty panel on user left.

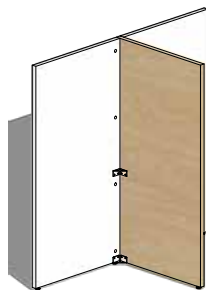

Shared End Panel

Model#	Depth	Width	Height	Weight	Cube	Price
ADEPB2548	1"	25"	48"	33	1	\$314
ADEPB2648	1"	26"	48"	34	1	\$321
ADEPB3148	1"	31"	48"	40	1	\$355
ADEPB3248	1"	32"	48"	42	1	\$362
ADEPB6048	1"	60"	48"	78	2	\$552
ADEPB6648	1"	66"	48"	86	2	\$593
ADEPB7248	1"	72"	48"	93	2	\$634
ADEPB7848	1"	78"	48"	101	2	\$675

Ships with hardware and pre-drilled connections to modesty panel on user left and right.

Privacy Panels

Note: Privacy panels must be secured to a combination of worksurfaces, pedestals and low credenzas for stability.

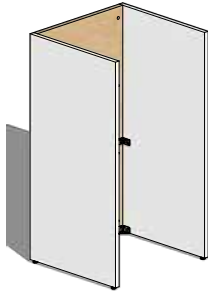

Modesty Panel

Model#	Depth	Width	Height	Weight	Cube	Price
ADMPA4848	1"	48"	48"	62	1	\$471
ADMPA6048	1"	60"	48"	78	2	\$552
ADMPA6648	1"	66"	48"	86	2	\$593
ADMPA7248	1"	72"	48"	93	2	\$634

Ships with hardware and pre-drilled connection to end panels on two vertical ends.

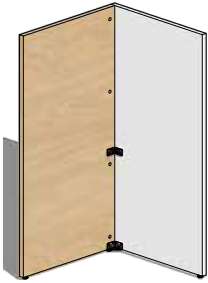

Modesty Panel End, Left

Model#	Depth	Width	Height	Weight	Cube	Price
ADMPBL2448	1"	24"	48"	31	1	\$307
ADMPBL3048	1"	30"	48"	39	1	\$348
ADMPBL3648	1"	36"	48"	47	1	\$389
ADMPBL4248	1"	42"	48"	55	1	\$430
ADMPBL4848	1"	48"	48"	62	1	\$471
ADMPBL6048	1"	60"	48"	78	2	\$552
ADMPBL6648	1"	66"	48"	86	2	\$593
ADMPBL7248	1"	72"	48"	93	2	\$634

Ships with hardware and pre-drilled connection to end panel on right vertical end.

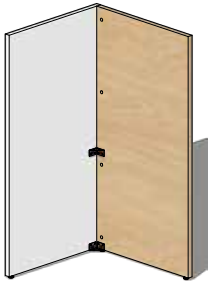

Modesty Panel End, Right

Model#	Depth	Width	Height	Weight	Cube	Price
ADMPBR2448	1"	24"	48"	31	1	\$307
ADMPBR3048	1"	30"	48"	39	1	\$348
ADMPBR3648	1"	36"	48"	47	1	\$389
ADMPBR4248	1"	42"	48"	55	1	\$430
ADMPBR4848	1"	48"	48"	62	1	\$471
ADMPBR6048	1"	60"	48"	78	2	\$552
ADMPBR6648	1"	66"	48"	86	2	\$593
ADMPBR7248	1"	72"	48"	93	2	\$634

Ships with hardware and pre-drilled connection to end panel on left vertical end.

Privacy Panels

Note: Privacy panels must be secured to a combination of worksurfaces, pedestals and low credenzas for stability.

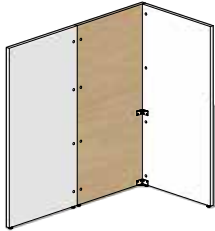

Spine End Panel, Left

Model#	Depth	Width	Height	Weight	Cube	Price
ADSPAL4848	1"	48"	48"	62	1	\$471
ADSPAL6048	1"	60"	48"	78	2	\$552
ADSPAL6648	1"	66"	48"	86	2	\$593
ADSPAL7248	1"	72"	48"	93	2	\$634
ADSPAL7848	1"	78"	48"	101	2	\$675

Ships with hardware and pre-drilled connection to modesty panel on user right and spine panel on opposite vertical end.

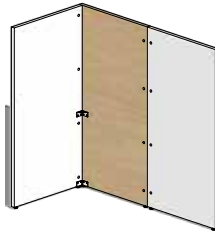

Spine End Panel, Right

Model#	Depth	Width	Height	Weight	Cube	Price
ADSPAR4848	1"	48"	48"	62	1	\$471
ADSPAR6048	1"	60"	48"	78	2	\$552
ADSPAR6648	1"	66"	48"	86	2	\$593
ADSPAR7248	1"	72"	48"	93	2	\$634
ADSPAR7848	1"	78"	48"	101	2	\$675

Ships with hardware and pre-drilled connection to modesty panel on user left and spine panel on opposite vertical end.

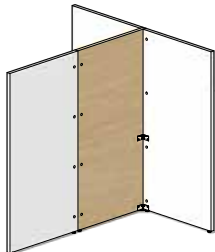

Shared Spine End Panel, Left

Model#	Depth	Width	Height	Weight	Cube	Price
ADSPBL4848	1"	48"	48"	62	1	\$471
ADSPBL6048	1"	60"	48"	78	2	\$552
ADSPBL6648	1"	66"	48"	86	2	\$593
ADSPBL7248	1"	72"	48"	93	2	\$634
ADSPBL7848	1"	78"	48"	101	2	\$675

Ships with hardware and pre-drilled connection to modesty panel on user right/left and spine panel on opposite vertical end. Cam lock holes on user left side.

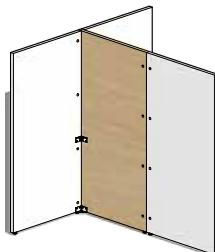

Shared Spine End Panel, Right

Model#	Depth	Width	Height	Weight	Cube	Price
ADSPBR4848	1"	48"	48"	62	1	\$471
ADSPBR6048	1"	60"	48"	78	2	\$552
ADSPBR6648	1"	66"	48"	86	2	\$593
ADSPBR7248	1"	72"	48"	93	2	\$634
ADSPBR7848	1"	78"	48"	101	2	\$675

Ships with hardware and pre-drilled connection to modesty panel on user right/left and spine panel on opposite vertical end. Cam lock holes on user right side.

Privacy Panels

Note: Privacy panels must be secured to a combination of worksurfaces, pedestals and low credenzas for stability.

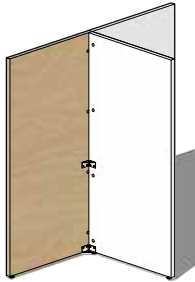

Shared Spine End Panel, Left

Model#	Depth	Width	Height	Weight	Cube	Price
ADSPCL2548	1"	25"	48"	33	1	\$314
ADSPCL2648	1"	26"	48"	34	1	\$321
ADSPCL3148	1"	31"	48"	40	1	\$355
ADSPCL3248	1"	32"	48"	42	1	\$362
ADSPCL6048	1"	60"	48"	78	2	\$552
ADSPCL6648	1"	66"	48"	86	2	\$593
ADSPCL7248	1"	72"	48"	93	2	\$634
ADSPCL7848	1"	78"	48"	101	2	\$675

Ships with hardware and pre-drilled connection to modesty panel on user right and spine panel on adjacent vertical end. Cam lock holes on user right side.

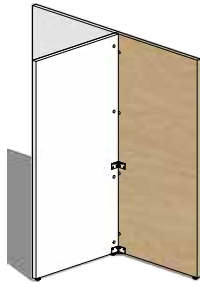

Shared Spine End Panel, Right

Model#	Depth	Width	Height	Weight	Cube	Price
ADSPCR2548	1"	25"	48"	33	1	\$314
ADSPCR2648	1"	26"	48"	34	1	\$321
ADSPCR3148	1"	31"	48"	40	1	\$355
ADSPCR3248	1"	32"	48"	42	1	\$362
ADSPCR6048	1"	60"	48"	78	2	\$552
ADSPCR6648	1"	66"	48"	86	2	\$593
ADSPCR7248	1"	72"	48"	93	2	\$634
ADSPCR7848	1"	78"	48"	101	2	\$675

Ships with hardware and pre-drilled connection to modesty panel on user left and spine panel on adjacent vertical end. Cam lock holes on user left side.

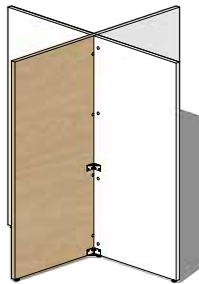

Shared Spine End Panel, Left

Model#	Depth	Width	Height	Weight	Cube	Price
ADSPDL2548	1"	25"	48"	33	1	\$314
ADSPDL2648	1"	26"	48"	34	1	\$321
ADSPDL3148	1"	31"	48"	40	1	\$355
ADSPDL3248	1"	32"	48"	42	1	\$362
ADSPDL6048	1"	60"	48"	78	2	\$552
ADSPDL6648	1"	66"	48"	86	2	\$593
ADSPDL7248	1"	72"	48"	93	2	\$634
ADSPDL7848	1"	78"	48"	101	2	\$675

Ships with hardware and pre-drilled connection to modesty panel on user right/left and spine panel on adjacent vertical end. Cam lock holes on user right side.

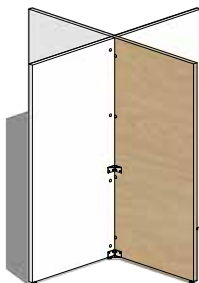

Shared Spine End Panel, Right

Model#	Depth	Width	Height	Weight	Cube	Price
ADSPDR2548	1"	25"	48"	33	1	\$314
ADSPDR2648	1"	26"	48"	34	1	\$321
ADSPDR3148	1"	31"	48"	40	1	\$355
ADSPDR3248	1"	32"	48"	42	1	\$362
ADSPDR6048	1"	60"	48"	78	2	\$552
ADSPDR6648	1"	66"	48"	86	2	\$593
ADSPDR7248	1"	72"	48"	93	2	\$634
ADSPDR7848	1"	78"	48"	101	2	\$675

Ships with hardware and pre-drilled connection to modesty panel on user right/left and spine panel on adjacent vertical end. Cam lock holes on user left side.

Privacy Panels

Note: Privacy panels must be secured to a combination of worksurfaces, pedestals and low credenzas for stability.

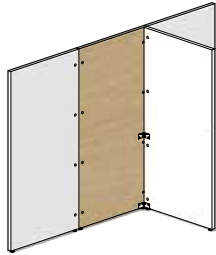

Spine End Panel, Left

Model#	Depth	Width	Height	Weight	Cube	Price
ADSPFL4848	1"	48"	48"	62	1	\$471
ADSPFL6048	1"	60"	48"	78	2	\$552
ADSPFL6648	1"	66"	48"	86	2	\$593
ADSPFL7248	1"	72"	48"	93	2	\$634
ADSPFL7848	1"	78"	48"	101	2	\$675

Ships with hardware and pre-drilled connection to modesty panel on user right and spine panel on both vertical ends.

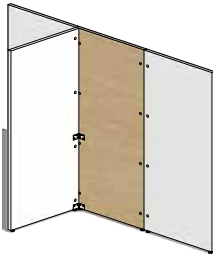

Spine End Panel, Right

Model#	Depth	Width	Height	Weight	Cube	Price
ADSPER4848	1"	48"	48"	62	1	\$471
ADSPER6048	1"	60"	48"	78	2	\$552
ADSPER6648	1"	66"	48"	86	2	\$593
ADSPER7248	1"	72"	48"	93	2	\$634
ADSPER7848	1"	78"	48"	101	2	\$675

Ships with hardware and pre-drilled connection to modesty panel on user left and spine panel on both vertical ends.

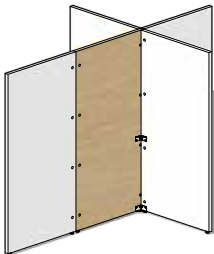

Shared Spine End Panel, Left

Model#	Depth	Width	Height	Weight	Cube	Price
ADSPFL4848	1"	48"	48"	62	1	\$471
ADSPFL6048	1"	60"	48"	78	2	\$552
ADSPFL6648	1"	66"	48"	86	2	\$593
ADSPFL7248	1"	72"	48"	93	2	\$634
ADSPFL7848	1"	78"	48"	101	2	\$675

Ships with hardware and pre-drilled connection to modesty panel on user right/left and spine panel on both vertical ends.

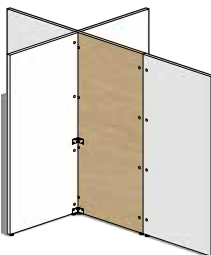

Shared Spine End Panel, Right

Model#	Depth	Width	Height	Weight	Cube	Price
ADSPFR4848	1"	48"	48"	62	1	\$471
ADSPFR6048	1"	60"	48"	78	2	\$552
ADSPFR6648	1"	66"	48"	86	2	\$593
ADSPFR7248	1"	72"	48"	93	2	\$634
ADSPFR7848	1"	78"	48"	101	2	\$675

Ships with hardware and pre-drilled connection to modesty panel on user left/right and spine panel on both vertical ends.

Privacy Panels

Note: Privacy panels must be secured to a combination of worksurfaces, pedestals and low credenzas for stability.

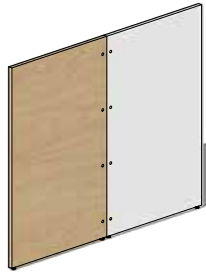

Spine Privacy Panel, Left

Model#	Depth	Width	Height	Weight	Cube	Price
ADSPGL2448	1"	24"	48"	31	1	\$307
ADSPGL3048	1"	30"	48"	39	1	\$348
ADSPGL6048	1"	60"	48"	78	2	\$552
ADSPGL6648	1"	66"	48"	86	2	\$593
ADSPGL7248	1"	72"	48"	93	2	\$634
ADSPGL7848	1"	78"	48"	101	2	\$675

Ships with hardware and pre-drilled connection to spine/privacy panel on user right vertical end. Cam locks on user right.

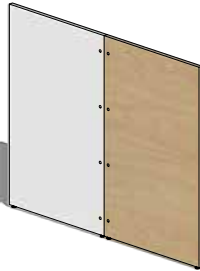

Spine Privacy Panel, Right

Model#	Depth	Width	Height	Weight	Cube	Price
ADSPGR2448	1"	24"	48"	31	1	\$307
ADSPGR3048	1"	30"	48"	39	1	\$348
ADSPGR6048	1"	60"	48"	78	2	\$552
ADSPGR6648	1"	66"	48"	86	2	\$593
ADSPGR7248	1"	72"	48"	93	2	\$634
ADSPGR7848	1"	78"	48"	101	2	\$675

Ships with hardware and pre-drilled connection to spine/privacy panel on user left vertical end. Cam locks on user left.

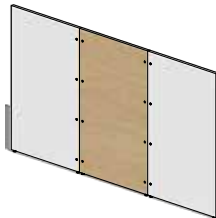

Shared Spine Privacy Panel

Model#	Depth	Width	Height	Weight	Cube	Price
ADSPH2448	1"	24"	48"	31	1	\$307
ADSPH3048	1"	30"	48"	39	1	\$348
ADSPH6048	1"	60"	48"	78	2	\$552
ADSPH6648	1"	66"	48"	86	2	\$593
ADSPH7248	1"	72"	48"	93	2	\$634
ADSPH7848	1"	78"	48"	101	2	\$675

Ships with hardware and pre-drilled connection to spine/privacy panel on both vertical ends.



Privacy End Panel

Model#	Depth	Width	Height	Weight	Cube	Price
ADPPI4948	1"	49 1/16"	48"	64	1	\$477
ADPPI6148	1"	61 1/16"	48"	79	2	\$559
ADPPI6648	1"	66"	48"	86	2	\$593
ADPPI7248	1"	72"	48"	93	2	\$634

Ships with hardware and pre-drilled connection to spine/privacy panel on center.

Privacy Panels

Note: Privacy panels must be secured to a combination of worksurfaces, pedestals and low credenzas for stability.

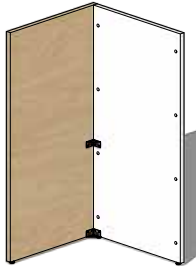

Privacy End Panel, Left

Model#	Depth	Width	Height	Weight	Cube	Price
ADPPJL2548	1"	25"	48"	33	1	\$314
ADPPJL2648	1"	26"	48"	34	1	\$321
ADPPJL3148	1"	31"	48"	40	1	\$355
ADPPJL3248	1"	32"	48"	42	1	\$362

Ships with hardware and pre-drilled connection to spine panel on right.

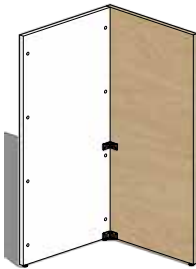

Privacy End Panel, Right

Model#	Depth	Width	Height	Weight	Cube	Price
ADPPJR2548	1"	25"	48"	33	1	\$314
ADPPJR2648	1"	26"	48"	34	1	\$321
ADPPJR3148	1"	31"	48"	40	1	\$355
ADPPJR3248	1"	32"	48"	42	1	\$362

Ships with hardware and pre-drilled connection to spine panel on left.



Privacy Panel

Model#	Depth	Width	Height	Weight	Cube	Price
ADPPK4848	1"	48"	48"	62	1	\$471
ADPPK6048	1"	60"	48"	78	2	\$552
ADPPK6648	1"	66"	48"	86	2	\$593
ADPPK7248	1"	72"	48"	93	2	\$634

Panel must be secured to worksurfaces or low credenzas with brackets.



Worksurfaces

Rectangular Worksurface (Grommet top center)

Model#	Depth	Width	Height	Weight	Cube	Price
ADRW2434	24"	34"	1"	22	0	\$256
ADRW2435	24"	35"	1"	23	0	\$260
ADRW2436	24"	36"	1"	24	1	\$263
ADRW2440	24"	40"	1"	26	1	\$277
ADRW2441	24"	41"	1"	27	1	\$281
ADRW2442	24"	42"	1"	27	1	\$284
ADRW2446	24"	46"	1"	30	1	\$298
ADRW2447	24"	47"	1"	30	1	\$302
ADRW2448	24"	48"	1"	31	1	\$305
ADRW2452	24"	52"	1"	34	1	\$319
ADRW2453	24"	53"	1"	34	1	\$323
ADRW2454	24"	54"	1"	35	1	\$326
ADRW2459	24"	59"	1"	38	1	\$344
ADRW2460	24"	60"	1"	39	1	\$347
ADRW2465	24"	65"	1"	42	1	\$365
ADRW2466	24"	66"	1"	43	1	\$368
ADRW2471	24"	71"	1"	46	1	\$387
ADRW2472	24"	72"	1"	47	1	\$390
ADRW3047	30"	47"	1"	38	1	\$342
ADRW3048	30"	48"	1"	39	1	\$346
ADRW3059	30"	59"	1"	48	1	\$394
ADRW3060	30"	60"	1"	48	1	\$398
ADRW3065	30"	65"	1"	52	1	\$420
ADRW3066	30"	66"	1"	53	1	\$424
ADRW3071	30"	71"	1"	57	1	\$446
ADRW3072	30"	72"	1"	58	1	\$450

Ships with L-brackets and wood screws for field install.

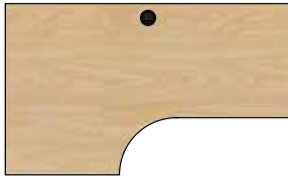

Worksurfaces

Compu-Corner Worksurface, Curved, Left (Grommet top center)

Model#	Depth	Corner	Width	Height	Weight	Cube	Price
ADCDQWL59242436	24/24"	36"	59"	1"	46	1	\$581
ADCDQWL60242436	24/24"	36"	60"	1"	47	1	\$586
ADCDQWL65242436	24/24"	36"	65"	1"	50	1	\$612
ADCDQWL66242436	24/24"	36"	66"	1"	50	1	\$617
ADCDQWL71242436	24/24"	36"	71"	1"	54	1	\$642
ADCDQWL72242436	24/24"	36"	72"	1"	54	2	\$648
ADCDQWL59302442	30/24"	42"	59"	1"	55	1	\$630
ADCDQWL60302442	30/24"	42"	60"	1"	56	1	\$636
ADCDQWL65302442	30/24"	42"	65"	1"	60	2	\$666
ADCDQWL66302442	30/24"	42"	66"	1"	61	2	\$672
ADCDQWL71302442	30/24"	42"	71"	1"	65	2	\$702
ADCDQWL72302442	30/24"	42"	72"	1"	66	2	\$708

Ships with L-brackets and wood screws for field install.

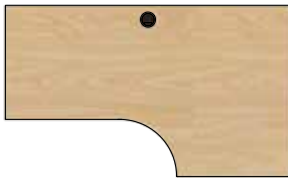

Compu-Corner Worksurface, Curved, Right (Grommet top center)

Model#	Depth	Corner	Width	Height	Weight	Cube	Price
ADCDQWR59242436	24/24"	36"	59"	1"	46	1	\$581
ADCDQWR60242436	24/24"	36"	60"	1"	47	1	\$586
ADCDQWR65242436	24/24"	36"	65"	1"	50	1	\$612
ADCDQWR66242436	24/24"	36"	66"	1"	50	1	\$617
ADCDQWR71242436	24/24"	36"	71"	1"	54	1	\$642
ADCDQWR72242436	24/24"	36"	72"	1"	54	2	\$648
ADCDQWR59302442	30/24"	42"	59"	1"	55	1	\$630
ADCDQWR60302442	30/24"	42"	60"	1"	56	1	\$636
ADCDQWR65302442	30/24"	42"	65"	1"	60	2	\$666
ADCDQWR66302442	30/24"	42"	66"	1"	61	2	\$672
ADCDQWR71302442	30/24"	42"	71"	1"	65	2	\$702
ADCDQWR72302442	30/24"	42"	72"	1"	66	2	\$708

Ships with L-brackets and wood screws for field install.

Worksurface Supports



External Stabilizer Bar, Black

Model#	Depth	Width	Height	Weight	Cube	Price
MMSB54	2"	35"	2"	5	1	\$141
MMSB60	2"	44"	2"	6	1	\$155
MMSB66	2"	50"	2"	7	1	\$167
MMSB72	2"	56"	2"	8	1	\$181

Required for tops larger than 35"W when supporting with left & right legs. Ships with wood screws for field install.

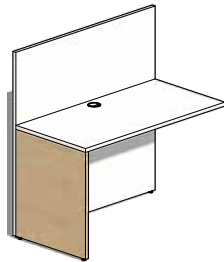

End Panel

Model#	Depth	Width	Height	Weight	Cube	Price
ADLEGA2428	1"	24"	28 1/8"	18	1	\$200
ADLEGA3028	1"	30"	28 1/8"	23	1	\$222

Ships with L-brackets and wood screws for field install.

Metal Legs

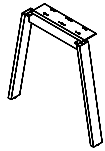

Apron Leg
(APOAL_)

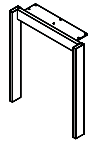

Double Post
(APODPL_)

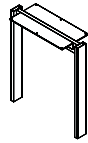

Shared Double Post Leg
(APDPML_)

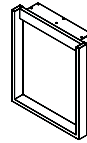

D-Leg
(APODL_)

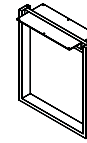

Shared D-Leg
(APMDL_)

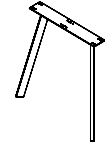

Tapered Metal Leg
(GROTL_)

Refer to Apex & Gravity Series for metal leg options and list prices.

Pedestals

Finished sides, exposed back

Mounting Box/Box/File Pedestal (H3B handles, face lock)



Model#	Depth	Width	Height	Weight	Cube	Price
ADPEDBBF18	18 1/2"	15 3/4"	28 1/8"	74	5	\$1,017

Ships with wood screws for field install below worksurface.

Mounting File/File Pedestal (H3B handles, face lock)



Model#	Depth	Width	Height	Weight	Cube	Price
ADPEDFF18	18 1/2"	15 3/4"	28 1/8"	84	5	\$900

Ships with wood screws for field install below worksurface.

Mounting Lateral File 2-Drawer Pedestal (H3B handles, face lock)

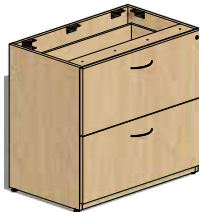

Model#	Depth	Width	Height	Weight	Cube	Price
ADPEDLF1830	18 1/2"	30 11/16"	28 1/8"	96	9	\$1,503
ADPEDLF1835	18 1/2"	35 7/8"	28 1/8"	106	11	\$1,558

Ships with wood screws and L-brackets for field install below worksurface.

Mounting Personal Lateral File Pedestal (H3B handles, face lock)

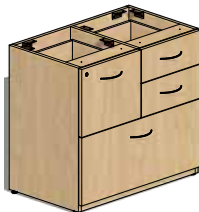

Model#	Depth	Width	Height	Weight	Cube	Price
ADPEDPLF1830	18 1/2"	30 11/16"	28 1/8"	121	9	\$1,804

Ships with wood screws and L-brackets for field install below worksurface.

Mounting 2-Hinged Door Cabinet Pedestal (H3B handles, face lock, 1 adjustable shelf 3/4")

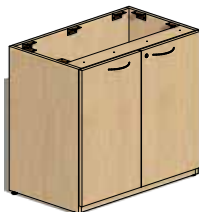

Model#	Depth	Width	Height	Weight	Cube	Price
ADPEDHDC1830	18 1/2"	30 11/16"	28 1/8"	105	9	\$1,228
ADPEDHDC1835	18 1/2"	35 7/8"	28 1/8"	115	11	\$1,281

Ships with wood screws and L-brackets for field install below worksurface.

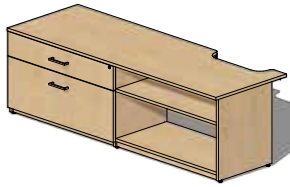

Low Credenzas

Low Credenza Single Box/Lateral/Bookcase, Left (H3B handles, face lock, 1 adj. shelf 3/4")

Model#	Depth	Width	Height	Lateral Width	Weight	Cube	Price
ADSBL2458L	24"	58 7/8"	22"	31"	135	18	\$2,040
ADSBL2464L	24"	64 7/8"	22"	36"	142	20	\$2,080
ADSBL2470L	24"	70 7/8"	22"	36"	151	22	\$2,130
ADSBL2476L	24"	76 7/8"	22"	36"	160	23	\$2,181

Ships with wood screws and L-brackets to secure privacy panels.

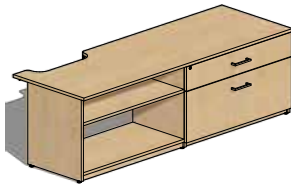

Low Credenza Single Box/Lateral/Bookcase, Right (H3B handles, face lock, 1 adj. shelf 3/4")

Model#	Depth	Width	Height	Lateral Width	Weight	Cube	Price
ADSBL2458L	24"	58 7/8"	22"	31"	135	18	\$2,040
ADSBL2464L	24"	64 7/8"	22"	36"	142	20	\$2,080
ADSBL2470L	24"	70 7/8"	22"	36"	151	22	\$2,130
ADSBL2476L	24"	76 7/8"	22"	36"	160	23	\$2,181

Ships with wood screws and L-brackets to secure privacy panels.

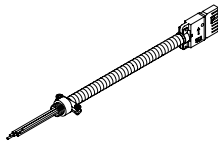

Power Management

Electrical Starter Cable (8 Wire, 4 Circuit)

Model#	Depth	Width	Height	Weight	Cube	Price
APESC72	1"	72"	1"	3	1	\$296

Must be connected to a building electrical supply by licensed electrician. (40) outlets maximum.



Daisy Chain Electrical Cable

Model#	Depth	Width	Height	Weight	Cube	Price
APDCE24	1"	24"	1"	2	1	\$209
APDCE36	1"	28"	1"	2	1	\$241
APDCE48	1"	40"	1"	2	1	\$266
APDCE54	1"	46"	1"	2	1	\$296
APDCE60	1"	52"	1"	3	1	\$296
APDCE66	1"	58"	1"	3	1	\$317
APDCE72	1"	64"	1"	3	1	\$328
APDCE78	1"	70"	1"	3	1	\$342
APDCE94	1"	86"	1"	3	1	\$369
APDCE100	1"	92"	1"	3	1	\$384
APDCE106	1"	98"	1"	3	1	\$398
APDCE112	1"	104"	1"	3	1	\$413



Split Cable (8 Wire, 4 circuit)

Model#	Depth	Width	Height	Weight	Cube	Price
APSF12	1"	12"	1"	1	1	\$196

Used to split into two directions as a "Y" coupler.

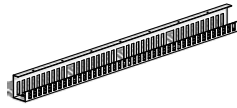

Power Management

Aluminum Wire Management Trough

Model#	Depth	Width	Height	Weight	Cube	Price
ADWM20	2 1/2"	20"	3 1/2"	1	1	\$106
ADWM32	2 1/2"	32"	3 1/2"	1	1	\$134
ADWM44	2 1/2"	44"	3 1/2"	1	1	\$160
ADWM56	2 1/2"	56"	3 1/2"	1	1	\$246
ADWM68	2 1/2"	68"	3 1/2"	1	1	\$291

Specify color available in Black, Silver and White. Ships with wood screws for field install.

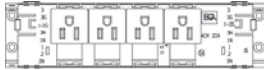

Single-Sided Power Box (4 Power outlets)

Model#	Depth	Width	Height	Weight	Cube	Price
APSSPB4	1 1/4"	9 5/16"	2 1/4"	1	1	\$231

Can be mounted below worksurfaces or in wire management troughs. Includes (1) circuit 1, (1) circuit 2, (1) circuit IG, (1) circuit 4. (Available for freestanding trough)

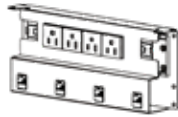

Power Module Single Sided Data Ready Unit (4 Power outlets & 4 RJ45)

Model#	Depth	Width	Height	Weight	Cube	Price
APSBS4	1 5/8"	10 1/2"	4 1/2"	1	1	\$1,125

No cut-out required. Field install under worksurface or onto a Privacy Panel. Mount hardware included. Hardwired Jack CAT 6. Color: Black with Orange Bezel.

Accessories

Tackboards

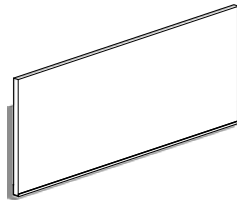

Model#	Depth	Width	Height	Weight	Cube	Price
MMTKBD2408	1/2"	24"	8"	4	1	\$370
MMTKBD3008	1/2"	30"	8"	5	1	\$405
MMTKBD3608	1/2"	36"	8"	6	1	\$440
MMTKBD4208	1/2"	42"	8"	7	1	\$473
MMTKBD4808	1/2"	48"	8"	8	1	\$509
MMTKBD5408	1/2"	54"	8"	9	1	\$543
MMTKBD6008	1/2"	60"	8"	10	1	\$577
MMTKBD6608	1/2"	66"	8"	11	1	\$616
MMTKBD7208	1/2"	72"	8"	12	1	\$646

Plastic rail included with wood screws for field install. Recommended for adjustable unit set ups.

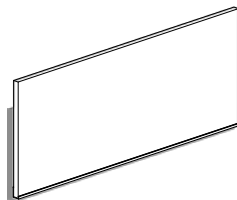

Tackboards

Model#	Depth	Width	Height	Weight	Cube	Price
MMTKBD24	1/2"	24"	14 1/4"	7	1	\$449
MMTKBD30	1/2"	30"	14 1/4"	9	1	\$590
MMTKBD36	1/2"	36"	14 1/4"	9	1	\$612
MMTKBD42	1/2"	42"	14 1/4"	12	1	\$634
MMTKBD48	1/2"	48"	14 1/4"	12	1	\$682
MMTKBD54	1/2"	54"	14 1/4"	15	1	\$725
MMTKBD60	1/2"	60"	14 1/4"	17	1	\$771
MMTKBD66	1/2"	66"	14 1/4"	19	1	\$824
MMTKBD72	1/2"	72"	14 1/4"	21	1	\$1,006

Plastic rail included with wood screws for field install. Recommended for stationary unit set ups.

Accessories

Frosted Acrylic Privacy Screen

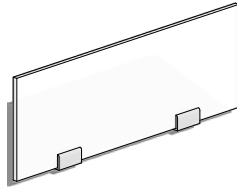

Model#	Depth	Width	Height	Mounting Clips	Weight	Cube	Price
ADPSF2408	3/8"	17"	8"	2	1	1	\$370
ADPSF3008	3/8"	23"	8"	2	2	1	\$405
ADPSF3608	3/8"	29"	8"	2	2	1	\$440
ADPSF4208	3/8"	35"	8"	2	2	1	\$473
ADPSF4808	3/8"	41"	8"	2	3	1	\$509
ADPSF5408	3/8"	47"	8"	3	3	1	\$543
ADPSF6008	3/8"	53"	8"	3	3	1	\$577
ADPSF6608	3/8"	59"	8"	3	4	1	\$616
ADPSF7208	3/8"	65"	8"	3	4	1	\$646

Screens: Width up to 41"W includes (2) mounting clips. Widths larger than 41"W include (3) mounting clips.

Aluminum Wall Track, Silver



Model#	Depth	Width	Height	Weight	Cube	Price
ADAWT24	1/2"	24"	4 3/4"	1	1	\$92
ADAWT30	1/2"	30"	4 3/4"	1	1	\$107
ADAWT36	1/2"	36"	4 3/4"	1	1	\$123
ADAWT42	1/2"	42"	4 3/4"	1	1	\$139
ADAWT48	1/2"	48"	4 3/4"	1	1	\$154
ADAWT54	1/2"	54"	4 3/4"	1	1	\$170
ADAWT60	1/2"	60"	4 3/4"	1	1	\$186
ADAWT66	1/2"	66"	4 3/4"	1	1	\$202
ADAWT72	1/2"	72"	4 3/4"	1	1	\$217

Required for hanging accessories. Includes screws to secure to privacy panels. (2) Black plastic end caps included.

File Hanger Letter Size, Steel Silver

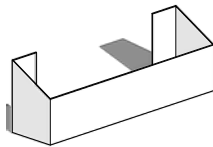

Model#	Depth	Width	Height	Weight	Cube	Price
ADLPHS	2 13/16"	12 3/8"	4 1/16"	1	1	\$45

Requires Aluminum Wall Track for hanging.

Pencil Box, Steel Silver

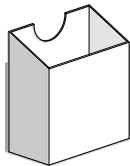

Model#	Depth	Width	Height	Weight	Cube	Price
ADPBS	2 9/16"	3 1/8"	3 9/16"	1	1	\$45

Requires Aluminum Wall Track for hanging.

Paper Tray Letter Size, Steel Silver



Model#	Depth	Width	Height	Weight	Cube	Price
ADLPTS	9 7/16"	13 1/8"	7/8"	1	1	\$76

Requires Aluminum Wall Track for hanging.

Pencil Tray, Steel Silver



Model#	Depth	Width	Height	Weight	Cube	Price
ADPTS	3 3/16"	7 5/8"	7/8"	1	1	\$45

Requires Aluminum Wall Track for hanging.

handle options



Crescent Black
(MMH3B)



Crescent Silver
(MMH3S)



Elliptical Black
(MMH5B)



Elliptical Silver
(MMH5S)



Crescent Textured Nickel
(MMH6)



Flared Nickel
(MMH7)



Bow Handle
(MMH8)



Curved Handle
(MMH9)



Bar Handle
(MMH13)



Bar Handle
(MMH14)



Bar Square Handle Black
(MMH10B)

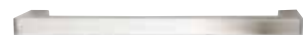

Bar Square Handle Silver
(MMH10S)



Bar Square Handle Silver
(MMH11)
\$94 list each



Bar Handle
(MMH30)
\$94 list each

standard features



Crescent Handle Black
(MMH3B)
and Face Lock



Plastic Grommet Black
(MMGR234B)



Plastic Grommet Silver
(MMGR234S)
May be specified at no charge

adapt TFM color options



tackboard fabric options

Anchorage 2335



Cape Cod 3073

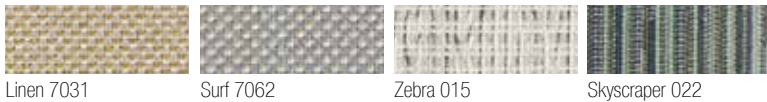

Tempest 2120

Metro 3077

Metallation 5118



Sprite 2671

Phrase 9508



Laminate finishes & fabric samples shown are approximations. Colors may vary between factories. TFM & HPL laminate finishes will vary.

For sample requests, email Maverick West: orderentry@maverickdesk.com. Maverick East: mveorders@maverickdesk.com

For actual fabric samples, go to: guilfordofmaine.com/swatches

Note: Renderings & line drawings shown are a resemblance to finished product. Product designs may vary. Discounts are different between factories.

Two standard colors may be specified at no charge. For three color combinations, email for quote.

adapt series

