

MAVERICK
OFFICE SOLUTIONS MADE IN THE U.S.A

PRICE LIST
MARCH 1, 2025

opriclik

contents

Maverick Series 2-23

Configurations 3-4

Desks 5-10

Bridges & Returns 11-13

Credenzas 14-19

Hutches 20

Bookcases, Storage & Files 21

Upgrades & Accessories 22-23

Conference & Training 24-31

Color Options 32

Place your order by NOON and ID as “Quick Ship” on the purchase order.

maverick series



Maverick Series, our most popular and complete series with the ability to mix and match two of our standard colors, provides modern day durability for any office space.

Features

Maverick Series is standard with full modesty panel, full to floor, face locking, handles. Hutch with fascia, grommets on credenzas, bridges and returns.

Edge Profile



Side View



maverick series

Configurations

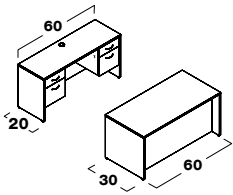

☞ MC1	
1 MCD3060	\$1,866
1 MCC2060 3	\$1,996
\$3,862	

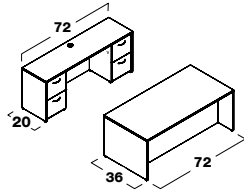

☞ MC2	
1 MCDC3672	\$3,140
1 MCCD2072 3	\$3,033
\$6,173	

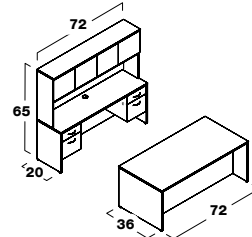

☞ MC3	
1 MCD3672	\$2,252
1 MCC2072 3	\$2,348
1 MCH72WD	\$2,065
\$6,665	

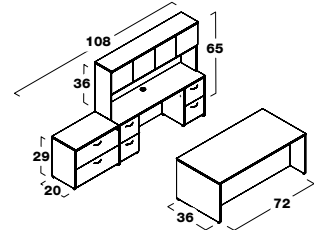

☞ MC4	
1 MCDC3672	\$3,140
1 MCCD2072 3	\$3,033
1 MCH72WD	\$2,065
1 MCLF202	\$1,759
\$9,997	

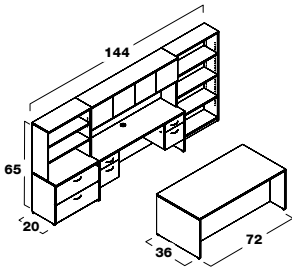

☞ MC5	
1 MCD3672	\$2,252
1 MCC2072 3	\$2,348
1 MCH72WD	\$2,065
1 MCLF202	\$1,759
1 MCBCH36	\$682
1 MCBC3665	\$1,185
\$10,291	

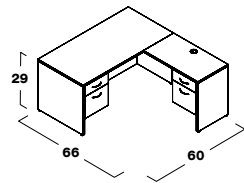

☞ MC6R	
1 MCS3060L	\$1,503
1 MCRA2036R	\$1,425
\$2,928	

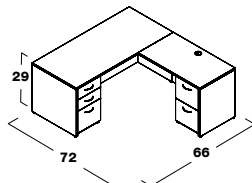

☞ MC7R	
1 MCSC3066L	\$2,292
1 MCRD2442R	\$2,132
\$4,424	

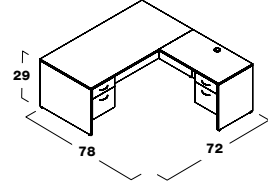

☞ MC8R	
1 MCS3672L	\$1,763
1 MCRA2442R	\$1,620
\$3,383	

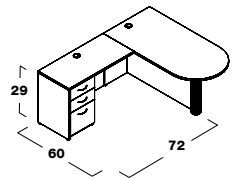

☞ MC9L	
1 MCB3060L	\$1,407
1 MCRC2042L	\$2,081
\$3,488	

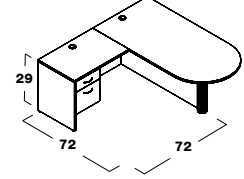

☞ MC10L	
1 MCB3672L	\$1,678
1 MCRA2436L	\$1,577
\$3,255	

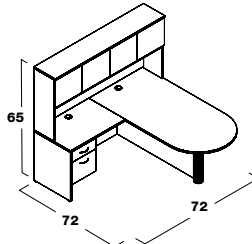

☞ MC11L	
1 MCB3672L	\$1,678
1 MCRA2436L	\$1,577
1 MCH72WD	\$2,065
\$5,320	

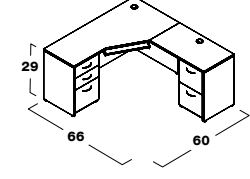

☞ MC12R	
1 MCCD66C 4L	\$2,521
1 MCRD2436R	\$2,116
\$4,637	

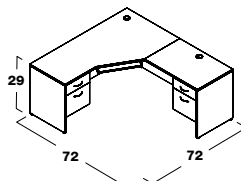

☞ MC13R	
1 MCCD72 4L	\$1,814
1 MCRA2436R	\$1,577
\$3,391	

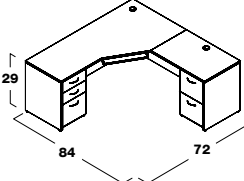

☞ MC14R	
1 MCCD72C 4L	\$2,439
1 MCRD2448R	\$2,180
\$4,619	

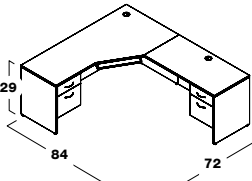

☞ MC15R	
1 MCCD72 4L	\$1,814
1 MCRA2448R	\$1,642
\$3,456	

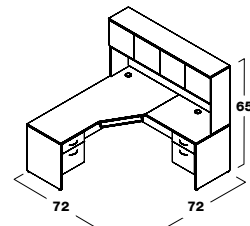

☞ MC16R	
1 MCCD72 4L	\$1,814
1 MCRA2436R	\$1,577
1 MCH72WD	\$2,065
\$5,456	

Use "R" or "L" to indicate the position of the return. Configurations are a small sample of total available. Configurations can be used with limited upgrade options for ☞.

maverick series

Configurations

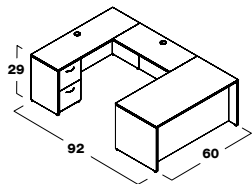

MC17L

1 MCSC3060R	\$2,132
1 MCBR2042	\$645
1 MCCD2060 4L	\$2,121
\$4,898	

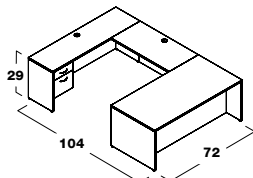

MC18L

1 MCS3672R	\$1,763
1 MCBR2448	\$851
1 MCC2072 4L	\$1,792
\$4,406	

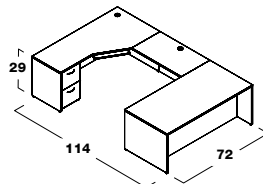

MC19L

1 MCSC3672R	\$2,396
1 MCBR2442	\$785
1 MCCD72D 4L	\$2,347
\$5,528	

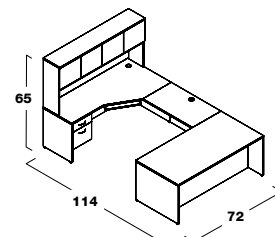

MC20L

1 MCS3672R	\$1,763
1 MCBR2442	\$785
1 MCCD72 4L	\$1,814
1 MCH72W	\$2,065
\$6,427	

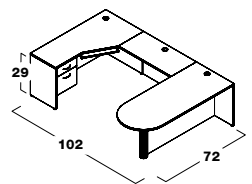

MC21L

1 MCB3072L	\$1,588
1 MCBR2042	\$645
1 MCCD60 2L	\$1,744
\$3,977	

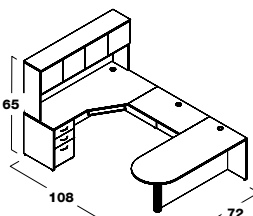

MC22L

1 MCB3072L	\$1,588
1 MCBR2442	\$785
1 MCCDC72 4L	\$2,439
1 MCH72WD	\$2,065
\$6,877	

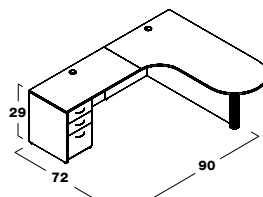

MCQ27L

1 MCBDCQ427230L	\$1,711
1 MCRC2448L	\$2,276
\$3,987	

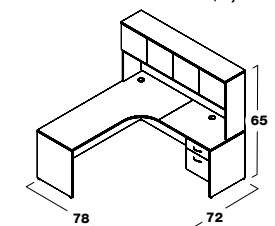

MCQ28R

1 MCCDNQ72 4R	\$1,542
1 MCRA2436R	\$1,577
1 MCH72WD	\$2,065
\$5,184	

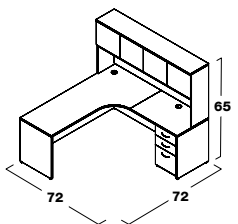

MCQ29R

1 MCCDNQ72 4R	\$1,542
1 MCRC2436R	\$2,208
1 MCH72WD	\$2,065
\$5,815	

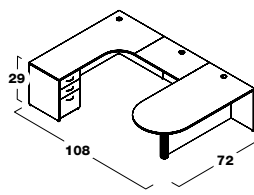

MCQ30L

1 MCB3672	\$1,678
1 MCBR2436	\$671
1 MCCDQ72C 4L	\$2,439
\$4,788	

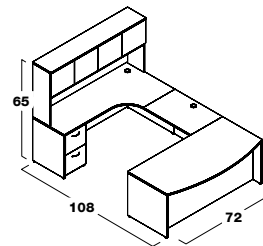

MCQ32L

1 MCFSC3672R	\$2,759
1 MCBR2436	\$671
1 MCCDQ72D 4L	\$2,347
1 MCH72WD	\$2,065
\$7,842	

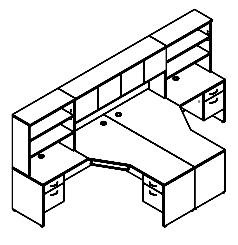

MC34

1 MCCD72 4R	\$1,814
1 MCCD72 4L	\$1,814
1 MCRA2436R	\$1,577
1 MCRA2436L	\$1,577
2 MCBCH36	\$1,364
1 MCH72 WD	\$2,065
\$10,211	

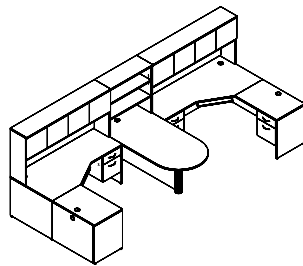

MC35

1 MCCD72 4R	\$1,814
1 MCCD72 4L	\$1,814
1 MCRA2436R	\$1,577
1 MCRA2436L	\$1,577
1 MCB3672L	\$1,678
2 MCH72WD	\$4,130
1 MCBCH	\$682
\$13,272	

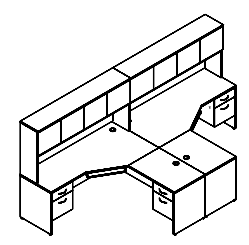

MC36

1 MCCD72 4R	\$1,814
1 MCCD72 4L	\$1,814
1 MCRA2436R	\$1,577
1 MCRA2436L	\$1,577
2 MCH72WD	\$4,130
\$10,912	

NOTE: BULLET DESK STAND ALONE WITH POST LEG WHEN ORDER AS MC35 CONFIGURATION, MUST SPECIFY.

maverick series

Desks

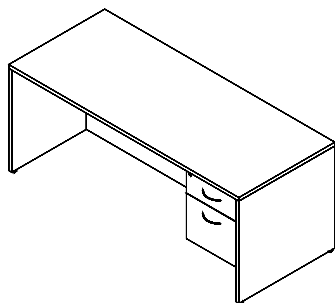

Single Pedestal Desk, Box/File Pedestal Right (Full modesty, H3B handles, lock)

Model#	Depth	Width	Height	Weight	Cube	Price
☞ MCS2042R	20"	42"	29"	120	15	\$1,392
☞ MCS2060R	20"	60"	29"	150	20	\$1,483
☞ MCS2066R	20"	66"	29"	156	23	\$1,643
☞ MCS2072R	20"	72"	29"	163	24	\$1,662
☞ MCS2442R	24"	42"	29"	127	18	\$1,433
☞ MCS2448R	24"	48"	29"	130	20	\$1,459
☞ MCS3048R	30"	48"	29"	142	25	\$1,479
☞ MCS3060R	30"	60"	29"	190	32	\$1,503
☞ MCS3066R	30"	66"	29"	197	35	\$1,662
☞ MCS3072R	30"	72"	29"	210	38	\$1,687
☞ MCS3672R	36"	72"	29"	225	45	\$1,763

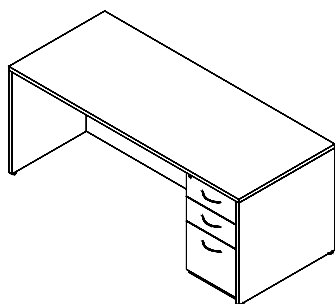

Single Pedestal Desk, Box/Box/File Pedestal Right (Full modesty, H3B handles, lock)

Model#	Depth	Width	Height	Weight	Cube	Price
☞ MCSC2042R	20"	42"	29"	155	15	\$2,020
☞ MCSC2060R	20"	60"	29"	180	20	\$2,107
☞ MCSC2066R	20"	66"	29"	190	23	\$2,268
☞ MCSC2072R	20"	72"	29"	200	24	\$2,292
☞ MCSC2442R	24"	42"	29"	175	18	\$2,065
☞ MCSC2448R	24"	48"	29"	183	20	\$2,090
☞ MCSC3048R	30"	48"	29"	203	25	\$2,107
☞ MCSC3060R	30"	60"	29"	224	32	\$2,132
☞ MCSC3066R	30"	66"	29"	234	35	\$2,292
☞ MCSC3072R	30"	72"	29"	244	38	\$2,314
☞ MCSC3672R	36"	72"	29"	267	45	\$2,396

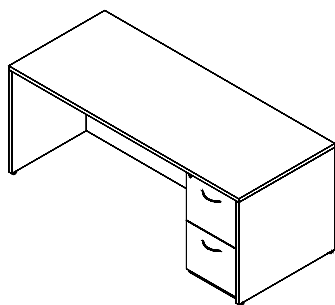

Single Pedestal Desk, File/File Pedestal Right (Full modesty, H3B handles, lock)

Model#	Depth	Width	Height	Weight	Cube	Price
☞ MCSD2042R	20"	42"	29"	155	15	\$1,928
☞ MCSD2060R	20"	60"	29"	180	20	\$2,017
☞ MCSD2066R	20"	66"	29"	190	23	\$2,177
☞ MCSD2072R	20"	72"	29"	200	24	\$2,198
☞ MCSD2442R	24"	42"	29"	175	18	\$1,971
☞ MCSD2448R	24"	48"	29"	183	20	\$1,998
☞ MCSD3048R	30"	48"	29"	203	25	\$2,017
☞ MCSD3060R	30"	60"	29"	224	32	\$2,039
☞ MCSD3066R	30"	66"	29"	234	35	\$2,198
☞ MCSD3072R	30"	72"	29"	244	38	\$2,224
☞ MCSD3672R	36"	72"	29"	267	45	\$2,302

For available accessories and upgrades, see pages 22–23.
Note: 60"W Single Pedestal Desks are recommended with 20"D Returns.

maverick series

Desks

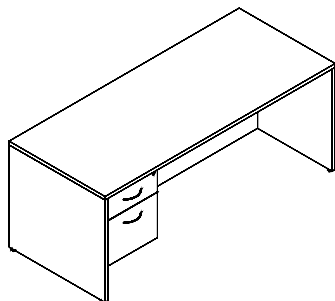

Single Pedestal Desk, Box/File Pedestal Left (Full modesty, H3B handles, lock)

Model#	Depth	Width	Height	Weight	Cube	Price
☞ MCS2042L	20"	42"	29"	120	15	\$1,392
☞ MCS2060L	20"	60"	29"	150	20	\$1,483
☞ MCS2066L	20"	66"	29"	156	23	\$1,643
☞ MCS2072L	20"	72"	29"	163	24	\$1,662
☞ MCS2442L	24"	42"	29"	127	18	\$1,433
☞ MCS2448L	24"	48"	29"	130	20	\$1,459
☞ MCS3048L	30"	48"	29"	142	25	\$1,479
☞ MCS3060L	30"	60"	29"	190	32	\$1,503
☞ MCS3066L	30"	66"	29"	197	35	\$1,662
☞ MCS3072L	30"	72"	29"	210	38	\$1,687
☞ MCS3672L	36"	72"	29"	225	45	\$1,763

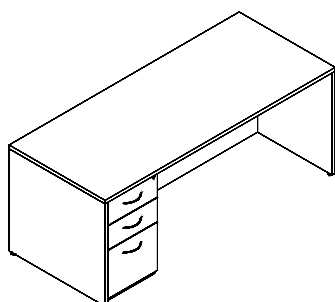

Single Pedestal Desk, Box/Box/File Pedestal Left (Full modesty, H3B handles, lock)

Model#	Depth	Width	Height	Weight	Cube	Price
☞ MCSC2042L	20"	42"	29"	120	15	\$2,020
☞ MCSC2060L	20"	60"	29"	150	20	\$2,107
☞ MCSC2066L	20"	66"	29"	156	23	\$2,268
☞ MCSC2072L	20"	72"	29"	163	24	\$2,292
☞ MCSC2442L	24"	42"	29"	127	18	\$2,065
☞ MCSC2448L	24"	48"	29"	130	20	\$2,090
☞ MCSC3048L	30"	48"	29"	142	25	\$2,107
☞ MCSC3060L	30"	60"	29"	190	32	\$2,132
☞ MCSC3066L	30"	66"	29"	197	35	\$2,292
☞ MCSC3072L	30"	72"	29"	210	38	\$2,314
☞ MCSC3672L	36"	72"	29"	225	45	\$2,396

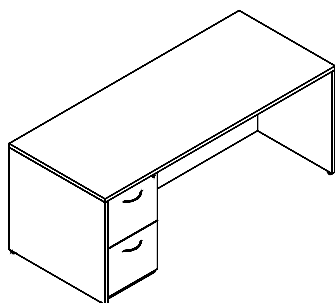

Single Pedestal Desk, File/File Pedestal Left (Full modesty, H3B handles, lock)

Model#	Depth	Width	Height	Weight	Cube	Price
☞ MCSD2042L	20"	42"	29"	120	15	\$1,928
☞ MCSD2060L	20"	60"	29"	150	20	\$2,017
☞ MCSD2066L	20"	66"	29"	156	23	\$2,177
☞ MCSD2072L	20"	72"	29"	163	24	\$2,198
☞ MCSD2442L	24"	42"	29"	127	18	\$1,971
☞ MCSD2448L	24"	48"	29"	130	20	\$1,998
☞ MCSD3048L	30"	48"	29"	142	25	\$2,017
☞ MCSD3060L	30"	60"	29"	190	32	\$2,039
☞ MCSD3066L	30"	66"	29"	197	35	\$2,198
☞ MCSD3072L	30"	72"	29"	210	38	\$2,224
☞ MCSD3672L	36"	72"	29"	225	45	\$2,302

For available accessories and upgrades, see pages 22–23.

Note: 60"W Single Pedestal Desks are recommended with 20"D Returns.

maverick series

Desks

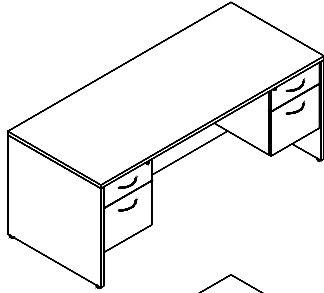

Double Pedestal Desk, Box/File Pedestals Left and Right
(Full modesty, H3B Handles, 2 locks)

Model#	Depth	Width	Height	Weight	Cube	Price
☞ MCD3060	30"	60"	29"	260	32	\$1,866
☞ MCD3066	30"	66"	29"	266	35	\$2,200
☞ MCD3072	30"	72"	29"	270	38	\$2,230
☞ MCD3672	36"	72"	29"	276	45	\$2,252

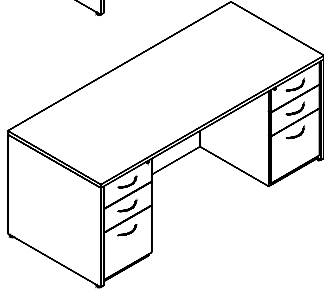

Double Pedestal Desk, Box/Box/File Pedestals Left and Right
(Full Modesty, H3B Handles, 2 locks)

Model#	Depth	Width	Height	Weight	Cube	Price
☞ MCDC3060	30"	60"	29"	294	32	\$2,678
☞ MCDC3066	30"	66"	29"	304	35	\$3,083
☞ MCDC3072	30"	72"	29"	314	38	\$3,118
☞ MCDC3672	36"	72"	29"	337	45	\$3,140

For left Box/Box/File and right File/File configuration use MCDCD_ at no charge.

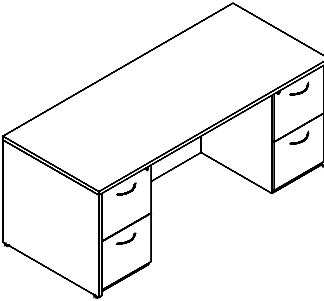

Double Pedestal Desk, File/File Pedestals Left and Right
(Full Modesty, H3B Handles, 2 locks)

Model#	Depth	Width	Height	Weight	Cube	Price
☞ MCDD3060	30"	60"	29"	294	32	\$2,556
☞ MCDD3066	30"	66"	29"	304	35	\$2,960
☞ MCDD3072	30"	72"	29"	314	38	\$2,992
☞ MCDD3672	36"	72"	29"	337	45	\$3,016

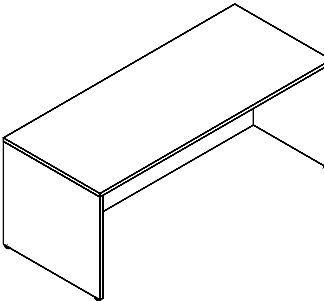

Desk Shell No-Pedestal, Full Modesty (Flush modesty)

Model#	Depth	Width	Height	Weight	Cube	Price
☞ MCN2042	20"	42"	29"	84	17	\$801
☞ MCN2048	20"	48"	29"	84	17	\$822
☞ MCN2060	20"	60"	29"	92	20	\$881
☞ MCN2066	20"	66"	29"	96	23	\$936
☞ MCN2072	20"	72"	29"	100	24	\$959
☞ MCN2436	24"	36"	29"	89	16	\$810
☞ MCN2442	24"	42"	29"	95	18	\$881
☞ MCN2448	24"	48"	29"	104	20	\$901
☞ MCN2460	24"	60"	29"	120	25	\$959
☞ MCN2466	24"	66"	29"	127	28	\$1,073
☞ MCN2472	24"	72"	29"	132	30	\$1,142

Modesty is flush.

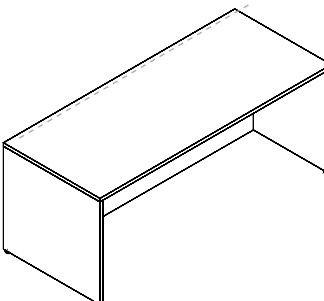

Desk Shell No-Pedestal, Full Modesty (30"D-6" inset modesty, 36"D-12" inset modesty)

Model#	Depth	Width	Height	Weight	Cube	Price
☞ MCN3042	30"	42"	29"	114	22	\$959
☞ MCN3048	30"	48"	29"	120	25	\$985
☞ MCN3060	30"	60"	29"	126	32	\$1,006
☞ MCN3066	30"	66"	29"	132	35	\$1,110
☞ MCN3072	30"	72"	29"	138	38	\$1,142
☞ MCN3672	36"	72"	29"	152	45	\$1,165

Modesty is Inset 6" on 30"D & 12" on 36"D.

For available accessories and upgrades, see pages 22–23.

maverick series

Desks

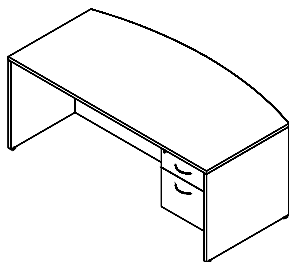

Fan Top Single Pedestal Desk, Box/File Right (Full modesty, H3B handles, lock)

Model#	Depth	Width	Height	Weight	Cube	Price
☞ MCF3672R	30-36"	72"	29"	233	45	\$2,129
☞ MCF4272R	36-42"	72"	29"	258	53	\$2,196

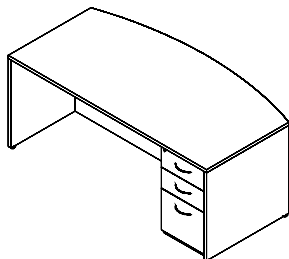

Fan Top Single Pedestal Desk, Box/Box/File Right (Full modesty, H3B handles, lock)

Model#	Depth	Width	Height	Weight	Cube	Price
☞ MCF3672R	30-36"	72"	29"	265	45	\$2,759
☞ MCF4272R	36-42"	72"	29"	280	53	\$2,825

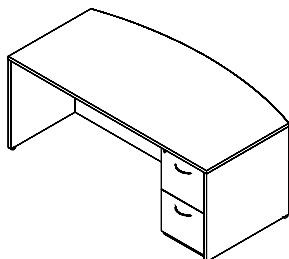

Fan Top Single Pedestal Desk, File/File Right (Full modesty, H3B handles, lock)

Model#	Depth	Width	Height	Weight	Cube	Price
☞ MCF3672R	30-36"	72"	29"	265	45	\$2,668
☞ MCF4272R	36-42"	72"	29"	280	53	\$2,729

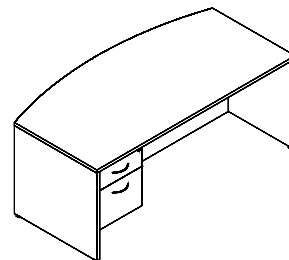

Fan Top Single Pedestal Desk, Box/File Left (Full modesty, H3B handles, lock)

Model#	Depth	Width	Height	Weight	Cube	Price
☞ MCF3672L	30-36"	72"	29"	233	45	\$2,129
☞ MCF4272L	36-42"	72"	29"	258	53	\$2,196

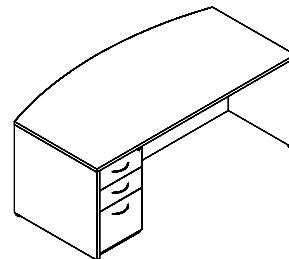

Fan Top Single Pedestal Desk, Box/Box/File Left (Full modesty, H3B handles, lock)

Model#	Depth	Width	Height	Weight	Cube	Price
☞ MCF3672L	30-36"	72"	29"	265	45	\$2,759
☞ MCF4272L	36-42"	72"	29"	280	53	\$2,825

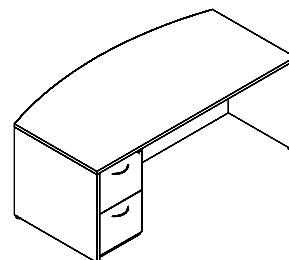

Fan Top Single Pedestal Desk, File/File Left (Full modesty, H3B handles, lock)

Model#	Depth	Width	Height	Weight	Cube	Price
☞ MCF3672L	30-36"	72"	29"	265	45	\$2,668
☞ MCF4272L	36-42"	72"	29"	280	53	\$2,729

For available accessories and upgrades, see pages 22–23.

maverick series

Desks

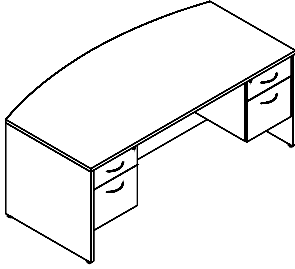

Fan Top Double Pedestal, Box/File Left and Right
(Full modesty, H3B handles, 2 locks)

Model#	Depth	Width	Height	Weight	Cube	Price
☞ MCFD3672	30-36"	72"	29"	280	45	\$2,654
☞ MCFD4272	36-42"	72"	29"	305	53	\$2,674

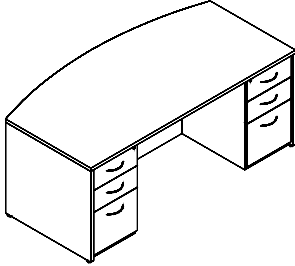

Fan Top Double Pedestal Desk, Box/Box/File Left and Right
(Full modesty, H3B handles, 2 locks)

Model#	Depth	Width	Height	Weight	Cube	Price
☞ MCFDC3672	30-36"	72"	29"	335	45	\$3,462
☞ MCFDC4272	36-42"	72"	29"	350	53	\$3,482

For left Box/Box/File and right File/File configuration use MCFDCD_____ at no charge.

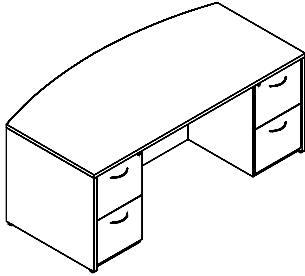

Fan Top Double Pedestal Desk, File/File Left and Right
(Full modesty, H3B handles, 2 locks)

Model#	Depth	Width	Height	Weight	Cube	Price
☞ MCFDD3672	30-36"	72"	29"	335	45	\$3,337
☞ MCFDD4272	36-42"	72"	29"	350	53	\$3,356

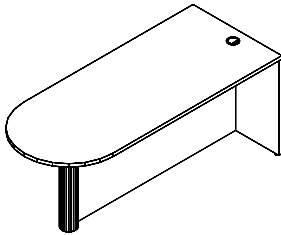

Bullet Desk, (Full modesty, 4" black post, centered black grommet) For Right Return

Model#	Depth	Width	Height	Weight	Cube	Price
☞ MCBD3060R	30"	60"	29"	180	32	\$1,407
☞ MCBD3072R	30"	72"	29"	195	35	\$1,588
☞ MCBD3660R	36"	60"	29"	185	38	\$1,588
☞ MCBD3672R	36"	72"	29"	205	45	\$1,678

For silver post upgrade, add at no charge. Upgrade grommet cover to silver at no charge.
Note: Specify if standalone. Standalone Bullet Desk is made with ½ leg (MMSPT) at no charge, replaces post leg.

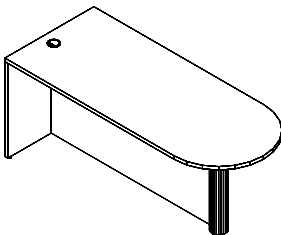

Bullet Desk, (Full modesty, 4" black post, centered black grommet) For Left Return

Model#	Depth	Width	Height	Weight	Cube	Price
☞ MCBD3060L	30"	60"	29"	180	32	\$1,407
☞ MCBD3072L	30"	72"	29"	195	35	\$1,588
☞ MCBD3660L	36"	60"	29"	185	38	\$1,588
☞ MCBD3672L	36"	72"	29"	205	45	\$1,678

For silver post upgrade, add at no charge. Upgrade grommet cover to silver at no charge.
Note: Specify if standalone. Standalone Bullet Desk is made with ½ leg (MMSPT) at no charge, replaces post leg.

For available accessories and upgrades, see pages 22–23.

maverick series

Desks

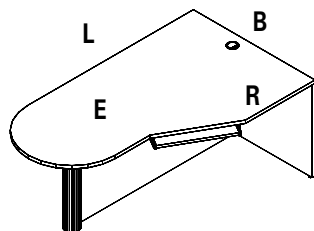

Bullet Computer Desk (Full modesty, 4" black post) For Right Return

Model#	Depth (B,E)	Width (L,R)	Height	Weight	Cube	Price
☞ MCBDC427230R	42/30"	72"/24"	29"	195	53	\$1,711
☞ MCBDC427830R	42/30"	78"/24"	29"	205	58	\$2,071

Keyboard tray and worksurface black grommet are standard. Upgrade grommet cover to silver at no charge. For silver post upgrade, add at no charge.

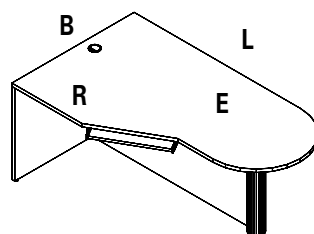

Bullet Computer Desk (Full modesty, 4" black post) For Left Return

Model#	Depth (B,E)	Width (L,R)	Height	Weight	Cube	Price
☞ MCBDC427230L	42/30"	72"/24"	29"	195	53	\$1,711
☞ MCBDC427830L	42/30"	78"/24"	29"	205	58	\$2,071

Keyboard tray and worksurface black grommet are standard. Upgrade grommet cover to silver at no charge. For silver post upgrade, add at no charge.

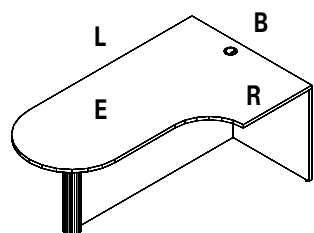

Bullet Computer Desk, Curved (Full modesty, 4" black post) For Right Return

Model#	Depth (B,E)	Width (L,R)	Height	Weight	Cube	Price
☞ MCBDCQ427230R	42/30"	72"/24"	29"	195	53	\$1,711

Worksurface black grommet standard. Upgrade grommet cover to silver at no charge. For silver post upgrade, add at no charge.

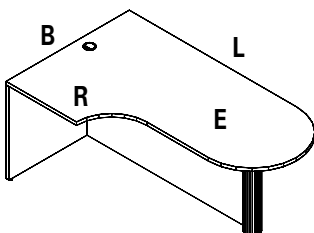

Bullet Computer Desk, Curved (Full modesty, 4" black post) For Left Return

Model#	Depth (B,E)	Width (L,R)	Height	Weight	Cube	Price
☞ MCBDCQ427230L	42/30"	72"/24"	29"	195	53	\$1,711

Worksurface black grommet standard. Upgrade grommet cover to silver at no charge. For silver post upgrade, add at no charge.

NOTE: All bullet computer desks specify if standalone. Standalone is made with 1/2 leg (MMSPT) at no charge, replaces post leg.

maverick series

Bridges

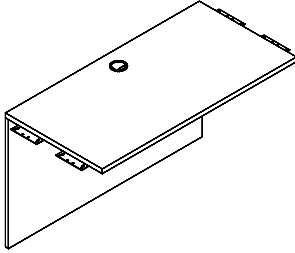

Bridge (Full modesty)

Model#	Depth	Width	Height	Weight	Cube	Price
☞ MCBR2036	20"	36"	29"	41	9	\$621
☞ MCBR2042	20"	42"	29"	48	10	\$645
☞ MCBR2048	20"	48"	29"	55	12	\$716
☞ MCBR2436	24"	36"	29"	47	10	\$671
☞ MCBR2442	24"	42"	29"	55	12	\$785
☞ MCBR2448	24"	48"	29"	63	14	\$851

Full modesty standard. ½ modesty on bridges may be specified at no upcharge.
Black grommet center top and modesty. Upgrade grommet cover to silver at no charge.

Returns

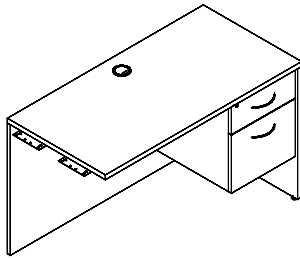

Return, ¾ Box/File Pedestal Right (Full modesty, H3B handles, lock)

Model#	Depth	Width	Height	Weight	Cube	Price
☞ MCRA2036R	20"	36"	29"	95	13	\$1,425
☞ MCRA2042R	20"	42"	29"	104	15	\$1,445
☞ MCRA2048R	20"	48"	29"	110	17	\$1,471
☞ MCRA2054R	20"	54"	29"	117	19	\$1,514
☞ MCRA2436R	24"	36"	29"	100	15	\$1,577
☞ MCRA2442R	24"	42"	29"	107	18	\$1,620
☞ MCRA2448R	24"	48"	29"	114	20	\$1,642
☞ MCRA2454R	24"	54"	29"	121	23	\$1,735
☞ MCRA2460R	24"	60"	29"	124	24	\$1,758
☞ MCRA3048R	30"	48"	29"	127	25	\$1,758

Full modesty standard. ½ modesty on returns may be specified at no upcharge.
Black grommet center top and modesty. Upgrade grommet cover to silver at no charge.

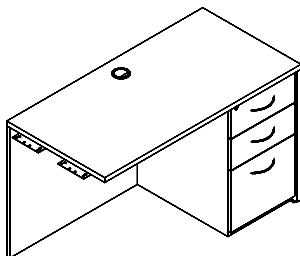

Return, Box/Box/File Pedestal Right (Full modesty, H3B handles, lock)

Model#	Depth	Width	Height	Weight	Cube	Price
☞ MCRC2036R	20"	36"	29"	130	13	\$2,060
☞ MCRC2042R	20"	42"	29"	140	15	\$2,081
☞ MCRC2048R	20"	48"	29"	150	17	\$2,107
☞ MCRC2054R	20"	54"	29"	160	19	\$2,153
☞ MCRC2436R	24"	36"	29"	140	15	\$2,208
☞ MCRC2442R	24"	42"	29"	150	18	\$2,256
☞ MCRC2448R	24"	48"	29"	160	20	\$2,276
☞ MCRC2454R	24"	54"	29"	170	23	\$2,370
☞ MCRC2460R	24"	60"	29"	180	24	\$2,389
☞ MCRC3048R	30"	48"	29"	175	25	\$2,389

Full modesty standard. ½ modesty on returns may be specified at no upcharge.
Black grommet center top and modesty. Upgrade grommet cover to silver at no charge.

For available accessories and upgrades, see pages 22–23.

maverick series

Returns

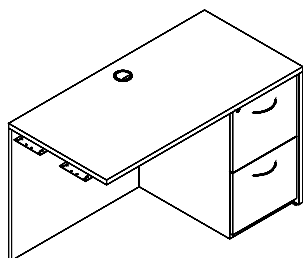

Return, File/File Pedestal Right (Full modesty, H3B handles, lock)

Model#	Depth	Width	Height	Weight	Cube	Price
☞ MCRD2036R	20"	36"	29"	130	13	\$1,962
☞ MCRD2042R	20"	42"	29"	140	15	\$1,985
☞ MCRD2048R	20"	48"	29"	150	17	\$2,009
☞ MCRD2054R	20"	54"	29"	160	19	\$2,056
☞ MCRD2436R	24"	36"	29"	140	15	\$2,116
☞ MCRD2442R	24"	42"	29"	150	18	\$2,132
☞ MCRD2448R	24"	48"	29"	160	20	\$2,180
☞ MCRD2454R	24"	54"	29"	170	23	\$2,277
☞ MCRD2460R	24"	60"	29"	180	24	\$2,292
☞ MCRD3048R	30"	48"	29"	175	25	\$2,292

Full modesty standard. ½ modesty on returns may be specified at no upcharge.
Black grommet center top and modesty. Upgrade grommet cover to silver at no charge.

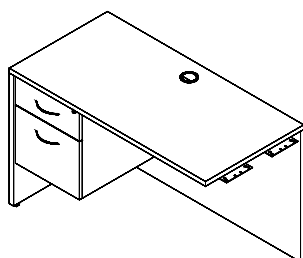

Return, ¾ Box/File Pedestal Left (Full modesty, H3B handles, lock)

Model#	Depth	Width	Height	Weight	Cube	Price
☞ MCRA2036L	20"	36"	29"	95	13	\$1,425
☞ MCRA2042L	20"	42"	29"	104	15	\$1,445
☞ MCRA2048L	20"	48"	29"	110	17	\$1,471
☞ MCRA2054L	20"	54"	29"	117	19	\$1,514
☞ MCRA2436L	24"	36"	29"	100	15	\$1,577
☞ MCRA2442L	24"	42"	29"	107	18	\$1,620
☞ MCRA2448L	24"	48"	29"	114	20	\$1,642
☞ MCRA2454L	24"	54"	29"	121	23	\$1,735
☞ MCRA2460L	24"	60"	29"	124	24	\$1,758
☞ MCRA3048L	30"	48"	29"	127	25	\$1,758

Full modesty standard. ½ modesty on returns may be specified at no upcharge.
Black grommet center top and modesty. Upgrade grommet cover to silver at no charge.

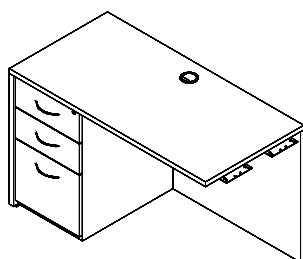

Return, Box/Box/File Pedestal Left (Full modesty, H3B handles, lock)

Model#	Depth	Width	Height	Weight	Cube	Price
☞ MCRC2036L	20"	36"	29"	130	13	\$2,060
☞ MCRC2042L	20"	42"	29"	140	15	\$2,081
☞ MCRC2048L	20"	48"	29"	150	17	\$2,107
☞ MCRC2054L	20"	54"	29"	160	19	\$2,153
☞ MCRC2436L	24"	36"	29"	140	15	\$2,208
☞ MCRC2442L	24"	42"	29"	150	18	\$2,256
☞ MCRC2448L	24"	48"	29"	160	20	\$2,276
☞ MCRC2454L	24"	54"	29"	170	23	\$2,370
☞ MCRC2460L	24"	60"	29"	180	24	\$2,389
☞ MCRC3048L	30"	48"	29"	175	25	\$2,389

Full modesty standard. ½ modesty on returns may be specified at no upcharge.
Black grommet center top and modesty. Upgrade grommet cover to silver at no charge.

For available accessories and upgrades, see pages 22–23.

maverick series

Returns

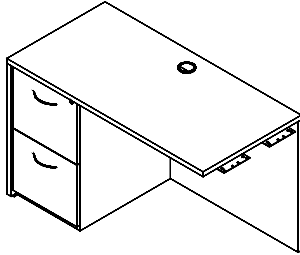

Return, File/File Pedestal Left (Full modesty, H3B handles, lock)

Model#	Depth	Width	Height	Weight	Cube	Price
MCRD2036L	20"	36"	29"	130	13	\$1,962
MCRD2042L	20"	42"	29"	140	15	\$1,985
MCRD2048L	20"	48"	29"	150	17	\$2,009
MCRD2054L	20"	54"	29"	160	19	\$2,056
MCRD2436L	24"	36"	29"	140	15	\$2,116
MCRD2442L	24"	42"	29"	150	18	\$2,132
MCRD2448L	24"	48"	29"	160	20	\$2,180
MCRD2454L	24"	54"	29"	170	23	\$2,277
MCRD2460L	24"	60"	29"	180	24	\$2,292
MCRD3048L	30"	48"	29"	175	25	\$2,292

Full modesty standard. ½ modesty on returns may be specified at no upcharge.
Black grommet center top and modesty. Upgrade grommet cover to silver at no charge.

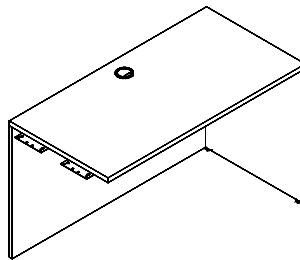

Return Shell Right (Full modesty)

Model#	Depth	Width	Height	Weight	Cube	Price
MCRN2036R	20"	36"	29"	60	13	\$785
MCRN2042R	20"	42"	29"	67	15	\$807
MCRN2048R	20"	48"	29"	73	17	\$884
MCRN2054R	20"	54"	29"	80	19	\$957
MCRN2436R	24"	36"	29"	63	15	\$968
MCRN2442R	24"	42"	29"	67	18	\$1,012
MCRN2448R	24"	48"	29"	74	20	\$1,062
MCRN2454R	24"	54"	29"	80	23	\$1,114
MCRN3048R	30"	48"	29"	89	25	\$1,181

Full modesty standard. ½ modesty on returns may be specified at no upcharge.
Black grommet center top and modesty. Upgrade grommet cover to silver at no charge.

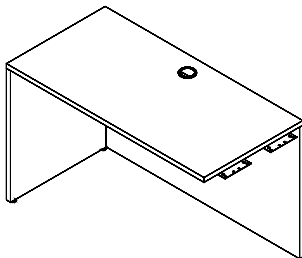

Return Shell Left (Full modesty)

Model#	Depth	Width	Height	Weight	Cube	Price
MCRN2036L	20"	36"	29"	60	13	\$785
MCRN2042L	20"	42"	29"	67	15	\$807
MCRN2048L	20"	48"	29"	73	17	\$884
MCRN2054L	20"	54"	29"	80	19	\$957
MCRN2436L	24"	36"	29"	63	15	\$968
MCRN2442L	24"	42"	29"	67	18	\$1,012
MCRN2448L	24"	48"	29"	74	20	\$1,062
MCRN2454L	24"	54"	29"	80	23	\$1,114
MCRN3048L	30"	48"	29"	89	25	\$1,181

Full modesty standard. ½ modesty on returns may be specified at no upcharge.
Black grommet center top and modesty. Upgrade grommet cover to silver at no charge.

For available accessories and upgrades, see pages 22–23.

maverick series

Credenzas

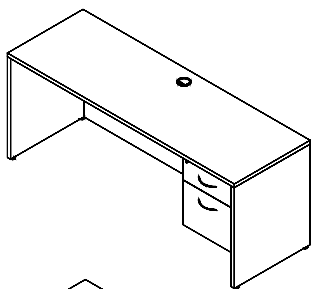

Credenza, Single Box/File Pedestal Right (Full modesty, H3B handles, lock)

Model#	Depth	Width	Height	Weight	Cube	Price
☞ MCC2060 4R	20"	60"	29"	150	21	\$1,609
☞ MCC2066 4R	20"	66"	29"	157	23	\$1,764
☞ MCC2072 4R	20"	72"	29"	164	25	\$1,792
☞ MCC2472 4R	24"	72"	29"	168	30	\$1,836

Black grommet center top and modesty. Upgrade grommet cover to silver at no charge.

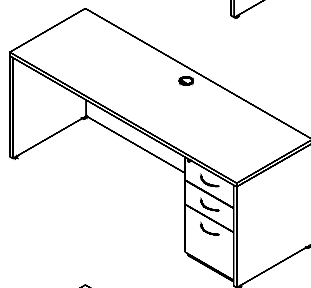

Credenza, Single Box/Box/File Pedestal Right (Full modesty, H3B handles, lock)

Model#	Depth	Width	Height	Weight	Cube	Price
☞ MCCC2060 4R	20"	60"	29"	185	21	\$2,218
☞ MCCC2066 4R	20"	66"	29"	190	23	\$2,393
☞ MCCC2072 4R	20"	72"	29"	200	25	\$2,416
☞ MCCC2472 4R	24"	72"	29"	220	30	\$2,465

Black grommet center top and modesty. Upgrade grommet cover to silver at no charge.

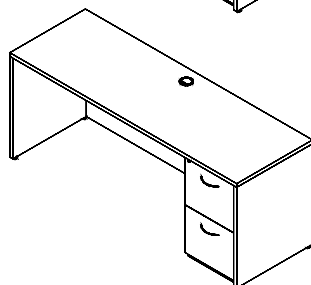

Credenza, Single File/File Pedestal Right (Full modesty, H3B handles, lock)

Model#	Depth	Width	Height	Weight	Cube	Price
☞ MCCD2060 4R	20"	60"	29"	183	21	\$2,121
☞ MCCD2066 4R	20"	66"	29"	190	23	\$2,302
☞ MCCD2072 4R	20"	72"	29"	200	25	\$2,324
☞ MCCD2472 4R	24"	72"	29"	220	30	\$2,371

Black grommet center top and modesty. Upgrade grommet cover to silver at no charge.

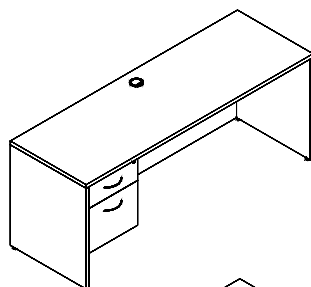

Credenza, Single Box/File Pedestal Left (Full modesty, H3B handles, lock)

Model#	Depth	Width	Height	Weight	Cube	Price
☞ MCC2060 4L	20"	60"	29"	150	21	\$1,609
☞ MCC2066 4L	20"	66"	29"	157	23	\$1,764
☞ MCC2072 4L	20"	72"	29"	164	25	\$1,792
☞ MCC2472 4L	24"	72"	29"	168	30	\$1,836

Black grommet center top and modesty. Upgrade grommet cover to silver at no charge.

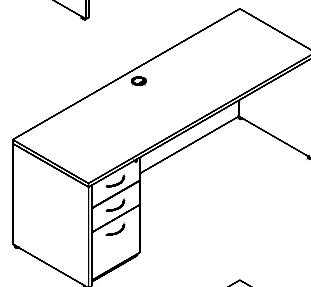

Credenza, Single Box/Box/File Pedestal Left (Full modesty, H3B handles, lock)

Model#	Depth	Width	Height	Weight	Cube	Price
☞ MCCC2060 4L	20"	60"	29"	185	21	\$2,218
☞ MCCC2066 4L	20"	66"	29"	190	23	\$2,393
☞ MCCC2072 4L	20"	72"	29"	200	25	\$2,416
☞ MCCC2472 4L	24"	72"	29"	220	30	\$2,465

Black grommet center top and modesty. Upgrade grommet cover to silver at no charge.

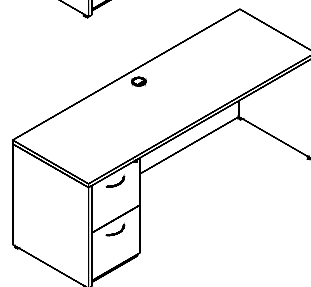

Credenza, Single File/File Pedestal Left (Full modesty, H3B handles, lock)

Model#	Depth	Width	Height	Weight	Cube	Price
☞ MCCD2060 4L	20"	60"	29"	183	21	\$2,121
☞ MCCD2066 4L	20"	66"	29"	190	23	\$2,302
☞ MCCD2072 4L	20"	72"	29"	200	25	\$2,324
☞ MCCD2472 4L	24"	72"	29"	220	30	\$2,371

Black grommet center top and modesty. Upgrade grommet cover to silver at no charge.

For available accessories and upgrades, see pages 22–23.

maverick series

CompuCorner Credenzas

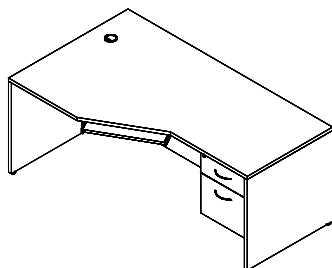

Computer Corner, Box/File Pedestal Right (H3B handles, lock, full modesty)

Model#	(L)	(B)	(E)	(K)	(R)	(W)	Weight	Cube	Price
MCCD60 2R	60"	30"	20"	21"	20"	21"	220	32	\$1,744
MCCD60 4R	60"	36"	24"	21"	24"	22"	220	32	\$1,764
MCCD66 4R	66"	36"	24"	21"	24"	24"	229	42	\$1,889
MCCD72 3R	72"	36"	20"	24"	20"	33"	249	45	\$1,996
MCCD72 4R	72"	36"	24"	21"	24"	30"	249	45	\$1,814
MCCD72 7R	72"	36"	24"	23"	20"	32"	285	45	\$1,970
MCCD72 8R	72"	42"	24"	24"	24"	33"	285	53	\$2,366

Keyboard tray & worksurface black grommet standard. Upgrade grommet cover to silver at no charge.

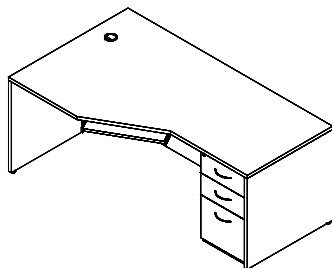

Computer Corner, Box/Box/File Pedestal Right (H3B handles, lock, full modesty)

Model#	(L)	(B)	(E)	(K)	(R)	(W)	Weight	Cube	Price
MCCD60C 2R	60"	30"	20"	21"	20"	21"	235	32	\$2,371
MCCD60C 4R	60"	36"	24"	21"	24"	22"	235	32	\$2,398
MCCD66C 4R	66"	36"	24"	21"	24"	24"	245	42	\$2,521
MCCD72C 3R	72"	36"	20"	24"	20"	33"	265	45	\$2,622
MCCD72C 4R	72"	36"	24"	21"	24"	30"	265	45	\$2,439
MCCD72C 7R	72"	36"	24"	23"	20"	32"	300	45	\$2,599
MCCD72C 8R	72"	42"	24"	24"	24"	33"	300	53	\$2,997

Keyboard tray & worksurface black grommet standard. Upgrade grommet cover to silver at no charge.

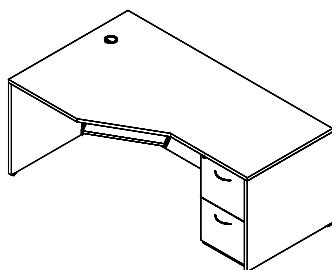

Computer Corner, File/File Pedestal Right (H3B handles, lock, full modesty)

Model#	(L)	(B)	(E)	(K)	(R)	(W)	Weight	Cube	Price
MCCD60D 2R	60"	30"	20"	21"	20"	21"	235	32	\$2,276
MCCD60D 4R	60"	36"	24"	21"	24"	22"	235	32	\$2,304
MCCD66D 4R	66"	36"	24"	21"	24"	24"	245	42	\$2,343
MCCD72D 3R	72"	36"	20"	24"	20"	33"	265	45	\$2,448
MCCD72D 4R	72"	36"	24"	21"	24"	30"	265	45	\$2,347
MCCD72D 7R	72"	36"	24"	23"	20"	32"	300	45	\$2,502
MCCD72D 8R	72"	42"	24"	24"	24"	33"	300	53	\$2,902

Keyboard tray & worksurface black grommet standard. Upgrade grommet cover to silver at no charge.

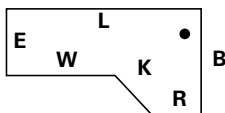

- "L" Length along approach edge
- "B" Back end panel
- "E" End panel
- "K" Keyboard space
- "R" Return size to attach
- "W" Workarea (kbrd to end)

For available accessories and upgrades, see pages 22–23.

maverick series

CompuCorner Credenzas

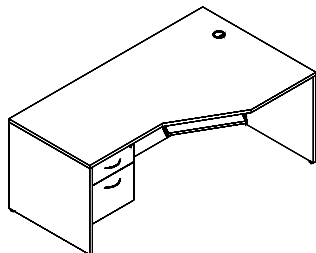

Computer Corner, Box/File Pedestal Left (H3B handles, lock, full modesty)

Model#	(L)	(B)	(E)	(K)	(R)	(W)	Weight	Cube	Price
☞ MCCD60 2L	60"	30"	20"	21"	20"	21"	220	32	\$1,744
☞ MCCD60 4L	60"	36"	24"	21"	24"	22"	220	32	\$1,764
☞ MCCD66 4L	66"	36"	24"	21"	24"	24"	229	42	\$1,889
☞ MCCD72 3L	72"	36"	20"	24"	20"	33"	249	45	\$1,996
☞ MCCD72 4L	72"	36"	24"	21"	24"	30"	249	45	\$1,814
☞ MCCD72 7L	72"	36"	24"	23"	20"	32"	285	45	\$1,970
☞ MCCD72 8L	72"	42"	24"	24"	24"	33"	285	53	\$2,366

Keyboard tray & worksurface black grommet standard. Upgrade grommet cover to silver at no charge.

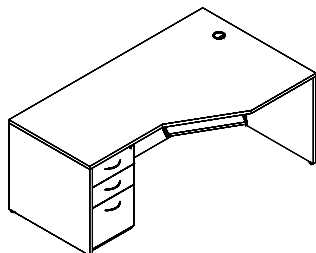

Computer Corner, Box/Box/File Pedestal Left (H3B handles, lock, full modesty)

Model#	(L)	(B)	(E)	(K)	(R)	(W)	Weight	Cube	Price
☞ MCCD60C 2L	60"	30"	20"	21"	20"	21"	235	32	\$2,371
☞ MCCD60C 4L	60"	36"	24"	21"	24"	22"	235	32	\$2,398
☞ MCCD66C 4L	66"	36"	24"	21"	24"	24"	245	42	\$2,521
☞ MCCD72C 3L	72"	36"	20"	24"	20"	33"	265	45	\$2,622
☞ MCCD72C 4L	72"	36"	24"	21"	24"	30"	265	45	\$2,439
☞ MCCD72C 7L	72"	36"	24"	23"	20"	32"	300	45	\$2,599
☞ MCCD72C 8L	72"	42"	24"	24"	24"	33"	300	53	\$2,997

Keyboard tray & worksurface black grommet standard. Upgrade grommet cover to silver at no charge.

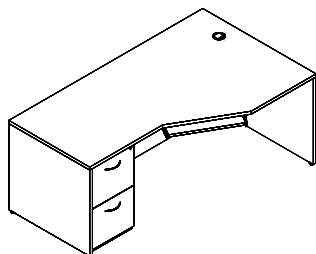

Computer Corner, File/File Pedestal Left (H3B handles, lock, full modesty)

Model#	(L)	(B)	(E)	(K)	(R)	(W)	Weight	Cube	Price
☞ MCCD60D 2L	60"	30"	20"	21"	20"	21"	235	32	\$2,276
☞ MCCD60D 4L	60"	36"	24"	21"	24"	22"	235	32	\$2,304
☞ MCCD66D 4L	66"	36"	24"	21"	24"	24"	245	42	\$2,343
☞ MCCD72D 3L	72"	36"	20"	24"	20"	33"	265	45	\$2,448
☞ MCCD72D 4L	72"	36"	24"	21"	24"	30"	265	45	\$2,347
☞ MCCD72D 7L	72"	36"	24"	23"	20"	32"	300	45	\$2,502
☞ MCCD72D 8L	72"	42"	24"	24"	24"	33"	300	53	\$2,902

Keyboard tray & worksurface black grommet standard. Upgrade grommet cover to silver at no charge.

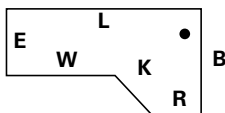

- "L" Length along approach edge
- "B" Back end panel
- "E" End panel
- "K" Keyboard space
- "R" Return size to attach
- "W" Workarea (kbrd to end)

For available accessories and upgrades, see pages 22–23.

maverick series

CompuCorner Credenzas

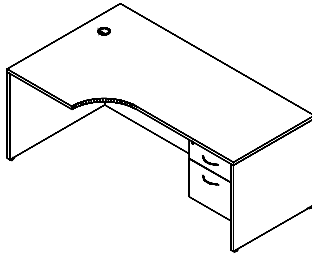

Computer Corner, Curved, ¾ Box/File Pedestal Right (H3B handles, lock, full modesty)

Model#	(L)	(B)	(E)	(K)	(R)	(W)	Weight	Cube	Price
☞ MCCDQ72 4R	72"	36"	24"	21"	24"	30"	239	45	\$1,814

No keyboard tray. Worksurface black grommet standard. Upgrade grommet cover to silver at no charge.

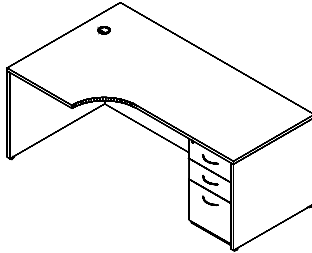

Computer Corner, Curved, Box/Box/File Pedestal Right (H3B handles, lock, full modesty)

Model#	(L)	(B)	(E)	(K)	(R)	(W)	Weight	Cube	Price
☞ MCCDQ72C 4R	72"	36"	24"	21"	24"	30"	254	45	\$2,439

No keyboard tray. Worksurface black grommet standard. Upgrade grommet cover to silver at no charge.

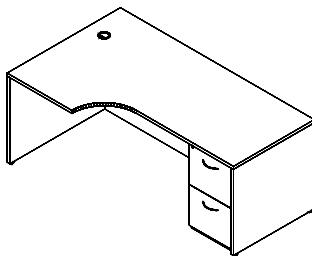

Computer Corner, Curved, File/File Pedestal Right (H3B handles, lock, full modesty)

Model#	(L)	(B)	(E)	(K)	(R)	(W)	Weight	Cube	Price
☞ MCCDQ72D 4R	72"	36"	24"	21"	24"	30"	254	45	\$2,347

No keyboard tray. Worksurface black grommet standard. Upgrade grommet cover to silver at no charge.

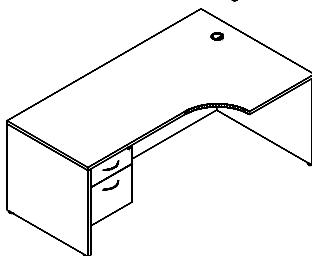

Computer Corner, Curved, ¾ Box/File Pedestal Left (H3B handles, lock, full modesty)

Model#	(L)	(B)	(E)	(K)	(R)	(W)	Weight	Cube	Price
☞ MCCDQ72 4L	72"	36"	24"	21"	24"	30"	239	45	\$1,814

No keyboard tray. Worksurface black grommet standard. Upgrade grommet cover to silver at no charge.

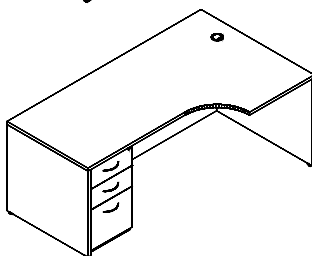

Computer Corner, Curved, Box/Box/File Pedestal Left (H3B handles, lock, full modesty)

Model#	(L)	(B)	(E)	(K)	(R)	(W)	Weight	Cube	Price
☞ MCCDQ72C 4L	72"	36"	24"	21"	24"	30"	254	45	\$2,439

No keyboard tray. Worksurface black grommet standard. Upgrade grommet cover to silver at no charge.

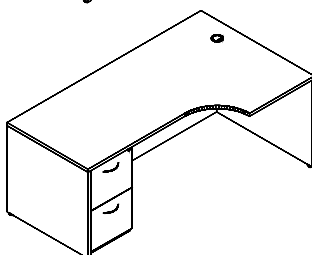

Computer Corner, Curved, File/File Pedestal Left (H3B handles, lock, full modesty)

Model#	(L)	(B)	(E)	(K)	(R)	(W)	Weight	Cube	Price
☞ MCCDQ72D 4L	72"	36"	24"	21"	24"	30"	254	45	\$2,347

No keyboard tray. Worksurface black grommet standard. Upgrade grommet cover to silver at no charge.

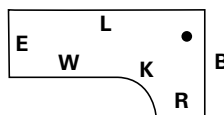

- "L" Length along approach edge
- "B" Back end panel
- "E" End panel
- "K" Keyboard space
- "R" Return size to attach
- "W" Workarea (kbrd to end)

For available accessories and upgrades, see pages 22–23.

maverick series

CompuCorner Credenzas

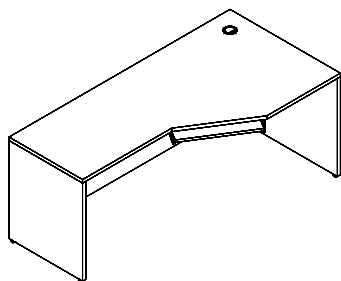

Computer Corner Shell (Full modesty), For Right Return

Model#	(L)	(B)	(E)	(K)	(R)	(W)	Weight	Cube	Price
MCCDN60 2R	60"	30"	20"	21"	20"	21"	184	32	\$1,286
MCCDN72 3R	72"	36"	20"	24"	20"	33"	213	45	\$1,491
MCCDN72 4R	72"	36"	24"	21"	24"	30"	213	45	\$1,542

Keyboard tray & worksurface black grommet standard. Upgrade grommet cover to silver at no charge.

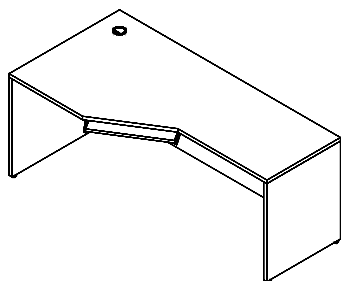

Computer Corner Shell (Full modesty), For Left Return

Model#	(L)	(B)	(E)	(K)	(R)	(W)	Weight	Cube	Price
MCCDN60 2L	60"	30"	20"	21"	20"	21"	184	32	\$1,286
MCCDN72 3L	72"	36"	20"	24"	20"	33"	213	45	\$1,491
MCCDN72 4L	72"	36"	24"	21"	24"	30"	213	45	\$1,542

Keyboard tray & worksurface black grommet standard. Upgrade grommet cover to silver at no charge.

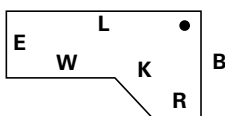

- "L" Length along approach edge
- "B" Back end panel
- "E" End panel
- "K" Keyboard space
- "R" Return size to attach
- "W" Workarea (kbrd to end)

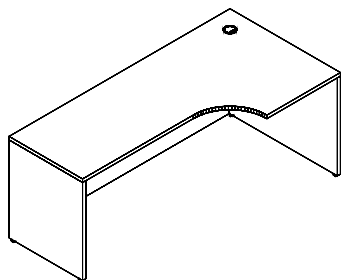

Computer Corner Shell, Curved (Full modesty), For Right Return

Model#	(L)	(B)	(E)	(K)	(R)	(W)	Weight	Cube	Price
MCCDNQ72 4R	72"	36"	24"	21"	24"	30"	213	45	\$1,542

No keyboard tray. Worksurface black grommet standard. Upgrade grommet cover to silver at no charge.

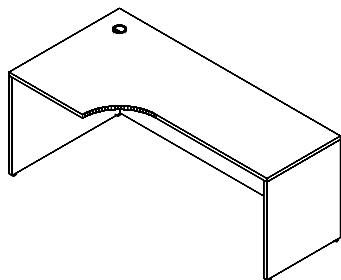

Computer Corner Shell, Curved (Full modesty), For Left Return

Model#	(L)	(B)	(E)	(K)	(R)	(W)	Weight	Cube	Price
MCCDNQ72 4L	72"	36"	24"	21"	24"	30"	213	45	\$1,542

No keyboard tray. Worksurface black grommet standard. Upgrade grommet cover to silver at no charge.

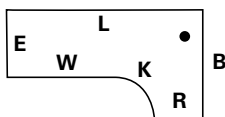

- "L" Length along approach edge
- "B" Back end panel
- "E" End panel
- "K" Keyboard space
- "R" Return size to attach
- "W" Workarea (kbrd to end)

For available accessories and upgrades, see pages 22–23.

maverick series

Credenzas

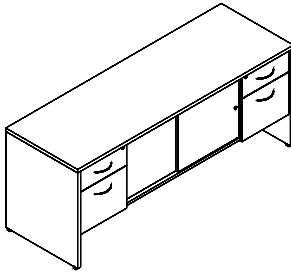

Credenza, Double Pedestal, Box/File Left and Right, Center Storage
(Sliding doors, full modesty, H3B handles, 2 locks)

Model#	Depth	Width	Height	Weight	Cube	Price
MCC2060 2	20"	60"	29"	230	21	\$1,970
MCC2066 2	20"	66"	29"	240	23	\$2,278
MCC2072 2	20"	72"	29"	250	25	\$2,297
MCC2472 2	24"	72"	29"	270	30	\$2,425

Storage includes one adjustable ¾" thick shelf. Sliding doors do not lock.

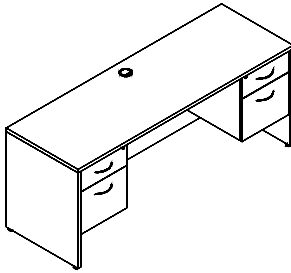

Credenza, Double Pedestal, Box/File Left and Right
(Knee space, full modesty, H3B handles, 2 locks)

Model#	Depth	Width	Height	Weight	Cube	Price
MCC2060 3	20"	60"	29"	196	21	\$1,996
MCC2066 3	20"	66"	29"	205	23	\$2,312
MCC2072 3	20"	72"	29"	210	25	\$2,348
MCC2472 3	24"	72"	29"	230	30	\$2,400

Black grommet center top and modesty. Upgrade grommet cover to silver at no charge.

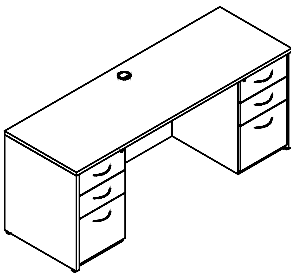

Credenza, Double Pedestal, Box/Box/File Left and Right
(Knee space, full modesty, H3B handles, 2 locks)

Model#	Depth	Width	Height	Weight	Cube	Price
MCCC2060 3	20"	60"	29"	245	21	\$2,805
MCCC2066 3	20"	66"	29"	255	23	\$3,123
MCCC2072 3	20"	72"	29"	265	25	\$3,155
MCCC2472 3	24"	72"	29"	290	30	\$3,210

Black grommet center top and modesty. Upgrade grommet cover to silver at no charge.
For left Box/Box/File and right File/File configuration, use MCCC_ at no charge.

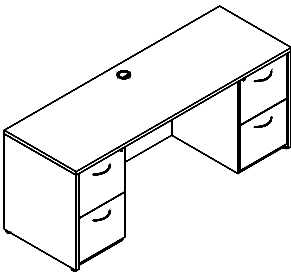

Credenza, Double Pedestal, File/File Left and Right
(Knee space, full modesty, H3B handles, 2 locks)

Model#	Depth	Width	Height	Weight	Cube	Price
MCCD2060 3	20"	60"	29"	245	21	\$2,676
MCCD2066 3	20"	66"	29"	255	23	\$2,999
MCCD2072 3	20"	72"	29"	265	25	\$3,033
MCCD2472 3	24"	72"	29"	290	30	\$3,085

Black grommet center top and modesty. Upgrade grommet cover to silver at no charge.

For available accessories and upgrades, see pages 22–23.

maverick series

Hutches

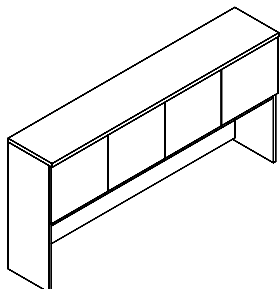

Hutch Four Doors with Fascia (18" below fascia)

Model#	Depth	Width	Height	# Doors	Weight	Cube	Price
☞ MCH48WD	14"	48"	36"	4	130	14	\$1,749
☞ MCH60WD	14"	60"	36"	4	155	18	\$1,870
☞ MCH66WD	14"	66"	36"	4	167	20	\$2,020
☞ MCH72WD	14"	72"	36"	4	179	21	\$2,065

Optional face locks (2 locks required), add MMFL \$118 each.
 Ends are 3/4" thick; doors overlay legs but are inset to the 1" thick top. Back panel 3/4" gap.
 For tasklights & tackboards, see page 52. 35lb. weight capacity distributed evenly.

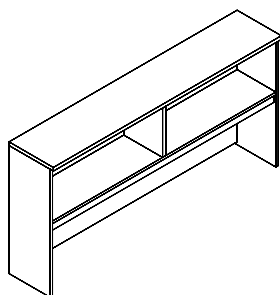

Hutch No Doors with Fascia (18" below fascia)

Model#	Depth	Width	Height	Weight	Cube	Price
☞ MCH48ND	14"	48"	36"	115	14	\$1,318
☞ MCH60ND	14"	60"	36"	135	18	\$1,361
☞ MCH66ND	14"	66"	36"	148	20	\$1,463
☞ MCH72ND	14"	72"	36"	160	21	\$1,600

Ends are 3/4" thick; doors overlay legs but are inset to the 1" thick top. Back panel 3/4" gap.
 For tasklights & tackboards, see page 52. 35lb. weight capacity distributed evenly.

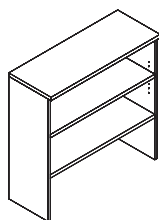

Bookcase Hutch, Full Back Panel

(One adjustable shelf, One fixed shelf, 1" thick shelves) Bottom Clearance 12"H

Model#	Depth	Width	Height#	Shelves	Weight	Cube	Price
☞ MCBCH36	14"	36"	36"	2	72	11	\$682

Ends are 3/4" thick; doors overlay legs but are inset to the 1" thick top.
 35lb. weight capacity distributed evenly.

NOTE: If hutch is being placed on L-unit return, 1/2 leg center support is recommended, add MMSPT \$97.

maverick series

Bookcases

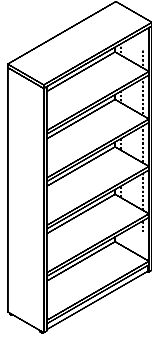

Bookcase (1" Thick adjustable shelves)

Model#	Depth	Width	Height	# Shelves	Weight	Cube	Price
☞ MCBC3630	12"	36"	29"	1	61	18	\$701
☞ MCBC3648	12"	36"	48"	2	86	12	\$944
☞ MCBC3660	12"	36"	60"	3	107	15	\$1,137
☞ MCBC3665	12"	36"	65"	3	111	17	\$1,185
☞ MCBC3672	12"	36"	72"	4	128	18	\$1,230
☞ MCBC3684	12"	36"	84"	5	137	21	\$1,537

For additional adjustable shelf, add MMSH1 \$171 ea. Includes 4 pins per shelf.
Adjustable shelves recommended weight is 20 lbs each, distributed evenly.

Storage

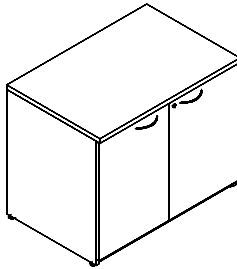

Hinged Door Utility Cabinet (H3B handles, one ¾" thick adjustable shelf, lock)

Model#	Depth	Width	Height	Weight	Cube	Price
☞ MCHDC2036	20"	36"	29"	115	13	\$1,350
☞ MCHDC2436	24"	36"	29"	175	15	\$1,534

Width coordinates with bookcase hutch.

Files

(All drawers are 16"D except vertical files)

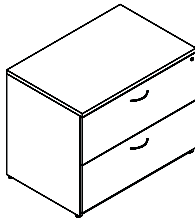

2-Drawer Lateral File (H3B handles, lock) Anti-Tip Interlock

Model#	Depth	Width	Height	Weight	Cube	Price
☞ MCLF202	20"	36"	29"	135	11	\$1,759
☞ MCLF242	24"	36"	29"	147	13	\$1,835

Includes anti-tip interlock.

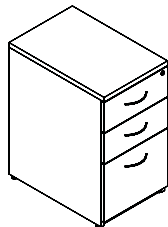

MCVFC

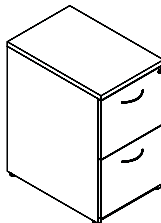

MCVF2

Vertical Files (H3B handles, lock)

Model#	Depth	Width	Height	20"D Drawers	Weight	Cube	Price
☞ MCVF2	24"	16"	29"	2	160	7	\$1,175
☞ MCVFC	24"	16"	29"	3	160	7	\$1,290

NOTE: All files recommended capacity is 75%, do not overload.

maverick series

Upgrade and Accessories

STANDARD HANDLE OPTIONS, FOR MAVERICK COMPLETE N/C.

H3B is standard if none specified.



Crescent Black
(MMH3B)



Crescent Silver
(MMH3S)



Elliptical Black
(MMH5B)



Elliptical Silver
(MMH5S)



Crescent Textured Nickel
(MMH6)



Flared Nickel
(MMH7)



Bow Handle
(MMH8)



Curved Handle
(MMH9)



Bar Square Handle
(MMH10B)



Bar Square Handle
(MMH10S)



Bar Handle
(MMH13)



Bar Handle
(MMH14)

GROMMETS



Grommet

Model#	Color	Depth	Width	Surface Hole Diameter	Price
MMGR234B	Black Plastic	3"	3"	2 3/4"	\$73
MMGR234S	Silver Plastic	3"	3"	2 3/4"	\$73
MMGR234BCOVER	Grommet cover only, Black (Field Install)				\$37
MMGR234SCOVER	Grommet cover only, Silver (Field Install)				\$37

Grommet Color, Upgrade from Standard Black to Silver

Model#	Color	Depth	Width	Surface Hole Diameter	Price
MMUGR234S	Silver Plastic	3"	3"	2 3/4"	No Charge

GROMMETS LOCATION (Worksurface and modesty)

NOTE: While sitting at unit, grommet locations named from left to right.
For grommet location on tops and/or modesty panel specify left, center or right.
No grommets over pedestals.

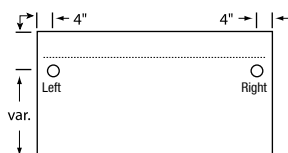

Desks

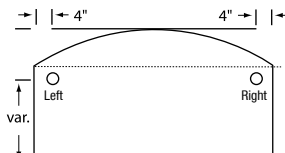

Desks

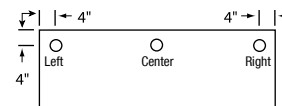

Credenza, Return,
Bridges

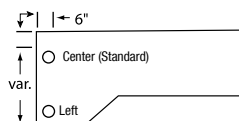

CompuCredenza

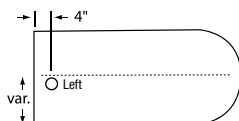

Bullets

Note: Black grommets are standard where shown on line drawings.

maverick series

Accessories and Upgrades

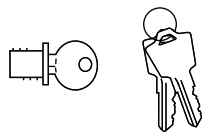

Face Lock

Model#	Description	Price
MMFL	Face lock for TFM doors or center drawers	\$118

MMFL: 1 per set of 2 doors. Hutch with 4 doors requires 2 locks.
Lock numbers (#101-115) are randomly assigned, key alike must be specify. No charge.

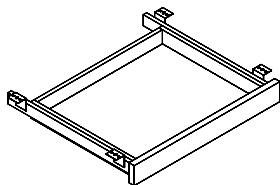

Center Drawer (9-ply birch wood drawer interior, specify front laminate color)

Model#	Depth	Width	Height	Weight	Cube	Price
MMCD	16"	21"	2 1/2"	12	.5	\$224



Box Drawer Convenience Tray, Black (Insets to box drawer)

Model#	Depth	Width	Height	Weight	Cube	Price
MMBPT	5 1/2"	12"	1"	1	.5	\$43

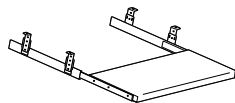

Keyboard Tray, Rollout (Specify laminate color)

Model#	Depth	Width	Height	Weight	Cube	Price
MMKB	16"	21"	3"	10	.5	\$204

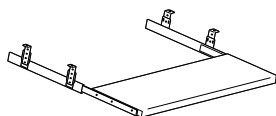

Oversize Keyboard Tray, Rollout (Specify laminate color)

Model#	Depth	Width	Height	Weight	Cube	Price
MMKBLG	16"	28"	3"	12	.5	\$301

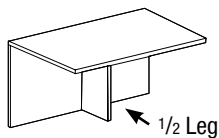

Half-Leg Support with Leveler (finished 3 sides)

Model#	Depth	Width	Height	Weight	Cube	Price
MMSPT	12"	1"	28"	11	3	\$97

Ships separately for field install. May be purchased for extra support.

conference collection & training tables

Maverick Series

1 $\frac{3}{4}$ " High built-up edge of thermally-fused melamine laminate with 2mm thick PVC edge band.
Radius corners. Round tables are 1" thick.

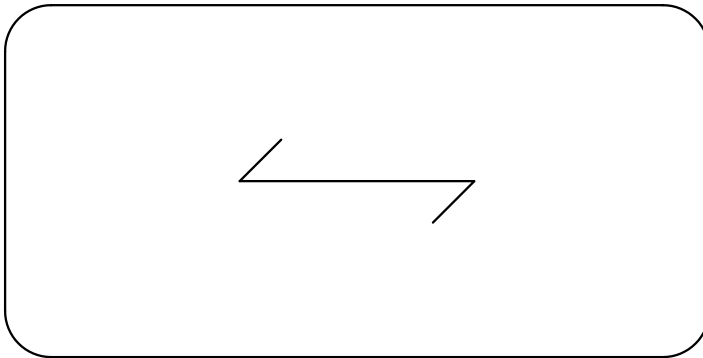

Edge Detail

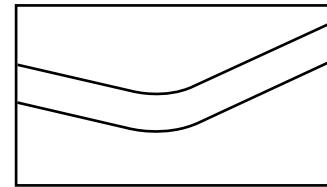

Arroyo Series

1" Thick top of thermally-fused melamine laminate with 2mm thick PVC edge band.
Square corners.

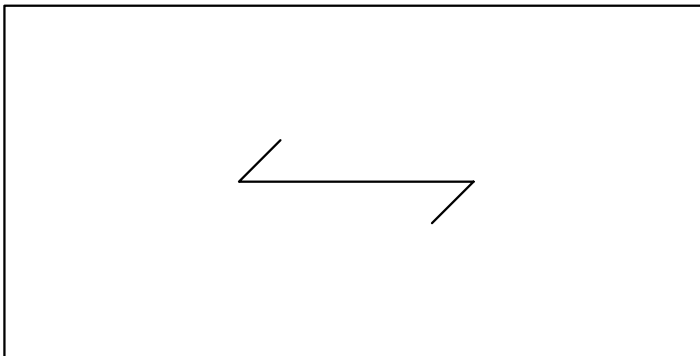

Edge Detail

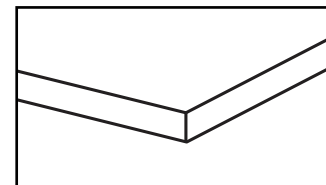

conference collection

Maverick Series - Conference Table Tops

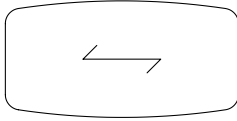

Boatshape Conference Table Top (1 3/4" Thick build up edge, radius corners)

Model#	Depth	Width	Height	Top	Weight	Cube	Price
☞ MMBS3672	30"/ 36"	72"	1 3/4"	1 pc	122	3	\$870
☞ MMBS4284	36"/ 42"	84"	1 3/4"	1 pc	156	4	\$998
☞ MMBS4296	36"/ 42"	96"	1 3/4"	1 pc	176	4	\$1,123

Tops require 2 bases.

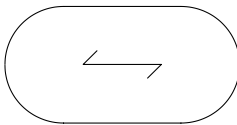

Racetrack Conference Table Top (1 3/4" Thick build up edge)

Model#	Depth	Width	Height	Top	Weight	Cube	Price
☞ MMRT3672	36"	72"	1 3/4"	1 pc	122	3	\$1,018
☞ MMRT4284	42"	84"	1 3/4"	1 pc	156	4	\$1,187
☞ MMRT4296	42"	96"	1 3/4"	1 pc	176	4	\$1,317

Tops require 2 bases.

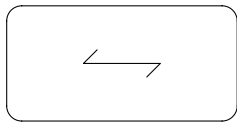

Rectangular Conference Table Top (1 3/4" Thick build up edge, radius corners)

Model#	Depth	Width	Height	Top	Weight	Cube	Price
☞ MMRE3672	36"	72"	1 3/4"	1 pc	122	3	\$826
☞ MMRE4284	42"	84"	1 3/4"	1 pc	156	4	\$870
☞ MMRE4296	42"	96"	1 3/4"	1 pc	176	4	\$1,039

Tops require 2 bases.

Round Table Tops

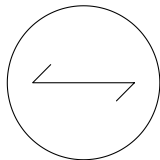

Round Table Table Top (1" Thick)

Model#	Depth	Width	Height	Bases (Required)	Weight	Cube	Price
☞ MMRD36	36"	36"	1"	1	36	6	\$597
☞ MMRD42	42"	42"	1"	1	49	7	\$723
☞ MMRD48	48"	48"	1"	1	64	8	\$913

REMINDER: Prices are for TOPS ONLY - Order legs/bases separately.

conference collection

Arroyo Series - Conference Table Tops

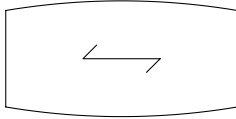

Boatshape Conference Table Top (1" Thick top, square corners)

Model#	Depth	Width	Height	Top	Weight	Cube	Price
ARBS3672	30"/ 36"	72"	1"	1 pc	72	2	\$699
ARBS4284	36"/ 42"	84"	1"	1 pc	97	2	\$826
ARBS4296	36"/ 42"	96"	1"	1 pc	111	3	\$931

Tops require 2 bases.

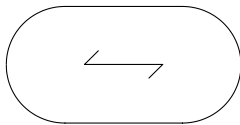

Racetrack Conference Table Top (1" Thick top)

Model#	Depth	Width	Height	Top	Weight	Cube	Price
ARRT3672	36"	72"	1"	1 pc	72	2	\$723
ARRT4284	42"	84"	1"	1 pc	97	2	\$849
ARRT4296	42"	96"	1"	1 pc	111	3	\$958

Tops require 2 bases.

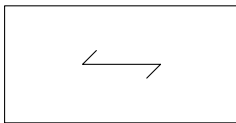

Rectangular Conference Table Top (1" Thick top, square corners)

Model#	Depth	Width	Height	Top	Weight	Cube	Price
ARRE3672	36"	72"	1"	1 pc	72	2	\$615
ARRE4284	42"	84"	1"	1 pc	97	2	\$743
ARRE4296	42"	96"	1"	1 pc	111	3	\$850

Tops require 2 bases.

Square Table Tops

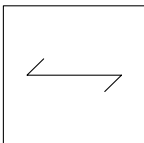

Square Table Table Top (1" Thick, square corners)

Model#	Depth	Width	Height	Bases (Required)	Weight	Cube	Price
ARSQ36	36"	36"	1"	1	36	1	\$597
ARSQ42	42"	42"	1"	1	49	1	\$723
ARSQ48	48"	48"	1"	1	64	2	\$913
ARSQ54	54"	54"	1"	1	80	2	\$1,039

REMINDER: Prices are for TOPS ONLY - Order legs/bases separately.

conference collection

Bases for Conference Table Tops

NOTE: Stretcher bars are standard when conference table top & square panel legs are purchased together.



Square Panel Leg, 1" Thick

Model#	Depth	Width	Height	Top Depth	Weight	Cube	Price
☞ ARLEGA20	1"	20"	28"	36"	27	1	\$139/ea.
☞ ARLEGA24	1"	24"	28"	42" & 48"	33	1	\$139/ea.

Use for Arroyo Conference Table Tops only. (AR legs do not support MM Conference Table Tops)
Stretcher bars 1"x7"H are standard (MMstretcher). Must order top and bases together.



Square Panel Leg, 1 3/4" Thick

Model#	Depth	Width	Height	Top Depth	Weight	Cube	Price
☞ MMLEGA20	1 3/4"	20"	28"	36"	27	1	\$219/ea.
☞ MMLEGA24	1 3/4"	24"	28"	42" & 48"	33	1	\$219/ea.

Stretcher bars 1"x7"H are standard (MMstretcher). Must order top and bases together.

NOTE: MMstretcher \$84 each, must specify top model# if ordering separately.

Bases for Round & Square Table Tops

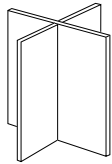

Flat Panel X-Base

Model#	Depth	Width	Height	Top Depth	Weight	Cube	Price
☞ MMLEGF20	20"	20"	28"	36"	31	7	\$341
☞ MMLEGF24	24"	24"	28"	42" & 48"	37	10	\$382



Sculptured Panel X-Base

Model#	Depth	Width	Height	Top Depth	Weight	Cube	Price
☞ MMLEGG20	20"	20"	28"	36"	31	7	\$439
☞ MMLEGG24	24"	24"	28"	42" & 48"	37	10	\$479

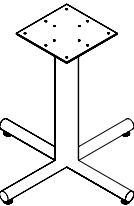

Four-Star Metal Base

Model#	Depth	Width	Height	Top Depth	Weight	Cube	Price
☞ MMLEGI30B	30"	30"	28"	36"	19	17	\$755
☞ MMLEGI30S	30"	30"	28"	36"	19	17	\$755
☞ MMLEGI36B	36"	36"	28"	42", 48" & 54"	30	24	\$820
☞ MMLEGI36S	36"	36"	28"	42", 48" & 54"	30	24	\$820

Color choice: MMLEGI_ _B (Black) and MMLEGI_ _S (Silver powdercoat)

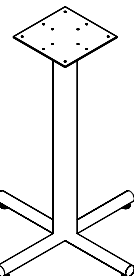

Bar Height Metal Four Star Base

Model#	Depth	Width	Height	Top Depth	Weight	Cube	Price
☞ MMLEGIBH30B	30"	30"	41"	36"	24	25	\$895
☞ MMLEGIBH30S	30"	30"	41"	36"	24	25	\$895
☞ MMLEGIBH36B	36"	36"	41"	42", 48", 54", 60"	35	35	\$961
☞ MMLEGIBH36S	36"	36"	41"	42", 48", 54", 60"	35	35	\$961

Color choice: MMLEGIBH_ _B (Black) and MMLEGIBH_ _S (Silver powdercoat)

conference collection

Bases for Round & Square Table Tops

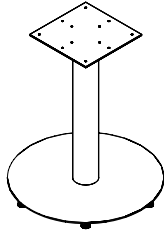

Round Disc Metal Base

Model#	Depth	Width	Height	Top Depth	Weight	Cube	Price
☞ MMLEGR24B	24"	4"	27 ³ / ₄ "	36", 42" & 48"	45	10	\$1,508
☞ MMLEGR24S	24"	4"	27 ³ / ₄ "	36", 42" & 48"	45	10	\$1,508
☞ MMLEGR28B	28"	4"	27 ³ / ₄ "	54"	50	13	\$1,730
☞ MMLEGR28S	28"	4"	27 ³ / ₄ "	54"	50	13	\$1,730

Color Choice: MMLEGR_ _B (Black) or MMLEGR_ _S (Silver powdercoat).

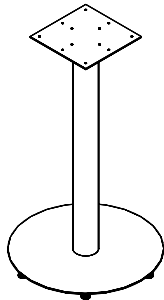

Round Disc Metal Base, Bar Height

Model#	Depth	Width	Height	Top Depth	Weight	Cube	Price
☞ MMLEGRBH24B	24"	4"	40 ³ / ₄ "	36" & 42"	50	14	\$1,645
☞ MMLEGRBH24S	24"	4"	40 ³ / ₄ "	36" & 42"	50	14	\$1,645
☞ MMLEGRBH28B	28"	4"	40 ³ / ₄ "	48"D	55	19	\$1,892
☞ MMLEGRBH28S	28"	4"	40 ³ / ₄ "	48"D	55	19	\$1,892

Color Choice: MMLEGRBH_ _B (Black) or MMLEGRBH_ _S (Silver powdercoat).

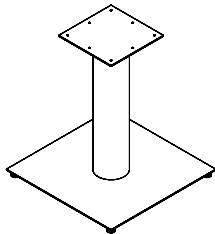

Square Metal Base

Model#	Depth	Width	Height	Top Depth	Weight	Cube	Price
☞ MMLEGS20B	20"	4"	27 ³ / ₄ "	36"	45	10	\$1,508
☞ MMLEGS20S	20"	4"	27 ³ / ₄ "	36"	45	10	\$1,508
☞ MMLEGS30B	30"	6"	27 ³ / ₄ "	42" & 48"	50	13	\$1,730
☞ MMLEGS30S	30"	6"	27 ³ / ₄ "	42" & 48"	50	13	\$1,730

Color Choice: MMLEGS_ _B (Black) or MMLEGS_ _S (Silver powdercoat).

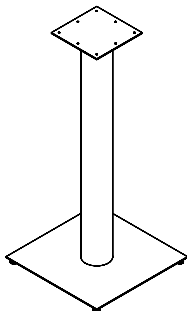

Square Metal Base, Bar Height

Model#	Depth	Width	Height	Top Depth	Weight	Cube	Price
☞ MMLEGSBH20B	20"	4"	40 ³ / ₄ "	36"	50	14	\$1,645
☞ MMLEGSBH20S	20"	4"	40 ³ / ₄ "	36"	50	14	\$1,645
☞ MMLEGSBH30B	30"	6"	40 ³ / ₄ "	42" & 48"	55	14	\$1,892
☞ MMLEGSBH30S	30"	6"	40 ³ / ₄ "	42" & 48"	55	14	\$1,892

Color Choice: MMLEGSBH_ _B (Black) or MMLEGSBH_ _S (Silver powdercoat).

training tables

Training Worksurfaces

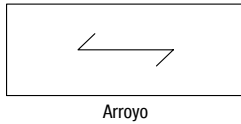
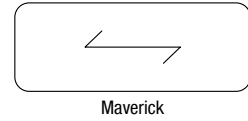
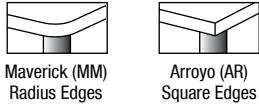

Rectangular Training Table Top, 20"D Tops (MM radius edges, AR square edges)

Model#	Depth	Width	Height	Weight	Cube	MM Price	AR Price
__TR2036	20"	36"	1"	23	1	\$282	\$251
__TR2042	20"	42"	1"	27	1	\$287	\$257
__TR2048	20"	48"	1"	30	1	\$301	\$272
__TR2054	20"	54"	1"	34	1	\$318	\$288
__TR2060	20"	60"	1"	38	1	\$364	\$328
__TR2066	20"	66"	1"	42	1	\$386	\$349
__TR2072*	20"	72"	1"	45	1	\$417	\$380
__TR2078*	20"	78"	1"	49	1	\$477	\$432
__TR2084*	20"	84"	1"	53	1	\$523	\$470

Note: When ordering, insert MM for Maverick Series or AR for Arroyo Series. Wood grain runs the width direction.
***Tops:** 72"W, 78"W & 84"W requires 5 post legs.
Stabilizer Bar: 2 are included with 60"W, 66"W & 72"W tops, when ordered with post legs.
 Max weight 50 lbs.
Pre Drill Holes: Tops are pre-drill for 4 post legs MMLEGTRB – MMLEGTRSC.
Ganging Hardware: Is recommended when placing tops side by side.  Lead Time.

Rectangular Training Table Top, 24"D Tops (MM radius edges, AR square edges)

Model#	Depth	Width	Height	Weight	Cube	MM Price	AR Price
__TR2436	24"	36"	1"	30	1	\$380	\$342
__TR2442	24"	42"	1"	32	1	\$392	\$355
__TR2448	24"	48"	1"	36	1	\$409	\$373
__TR2454	24"	54"	1"	40	1	\$425	\$386
__TR2460	24"	60"	1"	45	1	\$439	\$392
__TR2466	24"	66"	1"	50	1	\$463	\$417
__TR2472*	24"	72"	1"	54	1	\$477	\$432
__TR2478*	24"	78"	1"	59	1	\$523	\$470
__TR2484*	24"	84"	1"	63	1	\$554	\$499

Note: When ordering, insert MM for Maverick Series or AR for Arroyo Series. Wood grain runs the width direction.
***Tops:** 72"W, 78"W & 84"W requires 5 post legs.
Stabilizer Bar: 2 are included with 60"W, 66"W & 72"W tops, when ordered with post legs.
 Max weight 50 lbs.
Pre Drill Holes: Tops are pre-drill for 4 post legs MMLEGTRB – MMLEGTRSC.
Ganging Hardware: Is recommended when placing tops side by side.  Lead Time.

Rectangular Training Table Top, 30"D Tops (MM radius edges, AR square edges)

Model#	Depth	Width	Height	Weight	Cube	MM Price	AR Price
__TR3048	30"	48"	1"	45	1	\$392	\$355
__TR3054	30"	54"	1"	51	1	\$401	\$364
__TR3060	30"	60"	1"	57	1	\$440	\$392
__TR3066	30"	66"	1"	62	1	\$487	\$440
__TR3072*	30"	72"	1"	68	2	\$530	\$477
__TR3078*	30"	78"	1"	74	2	\$604	\$544
__TR3084*	30"	84"	1"	79	2	\$669	\$605

Note: When ordering, insert MM for Maverick Series or AR for Arroyo Series. Wood grain runs the width direction.
***Tops:** 72"W, 78"W & 84"W requires 5 post legs.
Stabilizer Bar: 2 are included with 60"W, 66"W & 72"W tops, when ordered with post legs.
 Max weight 50 lbs.
Pre Drill Holes: Tops are pre-drill for 4 post legs MMLEGTRB – MMLEGTRSC.
Ganging Hardware: Is recommended when placing tops side by side.  Lead Time.

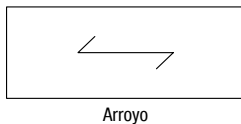
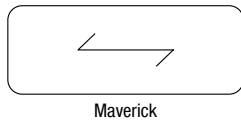

training tables

Training Worksurfaces

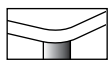

Maverick (MM)
Radius Edges

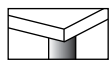

Arroyo (AR)
Square Edges

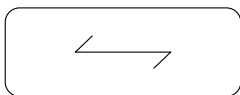

Maverick

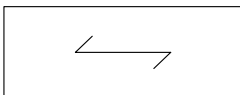

Arroyo

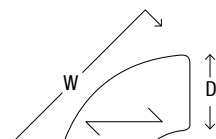

Maverick

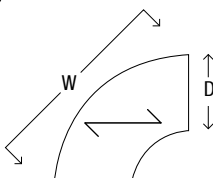

Arroyo

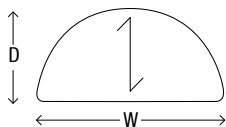

Maverick

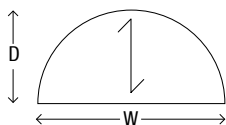

Arroyo

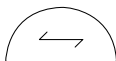

WG24 & WG30

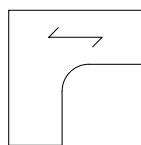
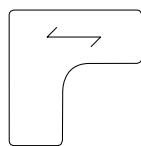

Maverick

Arroyo

Rectangular Training Table Top, 36" D Tops (MM radius edges, AR square edges)

Model#	Depth	Width	Height	Weight	Cube	MM Price	AR Price
__TR3660	36"	60"	1"	68	1	\$582	\$530
__TR3666	36"	66"	1"	75	1	\$630	\$568
__TR3672*	36"	72"	1"	81	2	\$659	\$599

Note: When ordering, insert MM for Maverick Series or AR for Arroyo Series. Wood grain runs the width direction.

*Top: 72"W requires 5 post legs.

Stabilizer Bar: 2 are included with 60"W, 66"W & 72"W tops, when ordered with post legs.

Max weight 50 lbs.

Pre Drill Holes: Tops are pre-drill for 4 post legs MMLEGTRB – MMLEGTRSC.

Ganging Hardware: Is recommended when placing tops side by side.  Lead Time.

Curved Training Table Top (Must be ganged with another top for stability)

Model#	Depth	Width	Height	Weight	Cube	MM Price	AR Price
__TRQ2460L	24"	60"	1"	27	1	\$448	\$404
__TRQ2460R	24"	60"	1"	27	1	\$448	\$404
__TRQ3060L	30"	60"	1"	33	2	\$495	\$448
__TRQ3060R	30"	60"	1"	33	2	\$495	\$448

Note: When ordering, insert MM for Maverick Series or AR for Arroyo before model number.

On "L" units, from users' view, woodgrain direction is parallel with right edge and perpendicular with left edge.

On "R" units wood-grain is parallel with the left edge and perpendicular with the right edge.

If not ganged, order 5th leg for stability.

Pre Drill Holes: Tops are pre-drill for post legs MMLEGTRB – MMLEGTRS.

Ganging Hardware: Is recommended when placing tops side by side.  Lead Time.

Half-Round Training Table Top (48" & 60" require four legs and two ganging plates)

Model#	Depth	Width	Height	Weight	Cube	MM Price	AR Price
__TRWH1224	12"	24"	1"	6	1	\$224	\$178
__TRWH1224WG24	12"	24"	1"	6	1	\$224	\$178
__TRWH1530	15"	30"	1"	10	1	\$271	\$225
__TRWH1530WG30	15"	30"	1"	10	1	\$271	\$225
__TRWH2448	24"	48"	1"	24	1	\$565	\$519
__TRWH3060	30"	60"	1"	37	1	\$675	\$519

Note: When ordering, insert MM for Maverick Series or AR for Arroyo before model number.

Woodgrain direction runs the depth to coordinate with woodgrain direction on rectangular worksurfaces.

12" & 15" deep require only 1 leg and 1 ganging plate.

12" & 15" deep (WG24 & WG30), the woodgrain runs the width to coordinate with the grain on 1 end of curved units.

Pre Drill Holes: Tops are pre-drill for post legs MMLEGTRB – MMLEGTRS.

Ganging Hardware: Is recommended when placing tops side by side.  Lead Time.

Curved Corner Training Table Top (48" & 60" require four legs and two ganging plates)

Model#	Depth	Width	Height	Weight	Cube	MM Price	AR Price
__TRCWS424224	24"	42" / 42"	1"	24	1	\$581	\$519
__TRCWS424230	30"	42" / 42"	1"	24	1	\$581	\$519
__TRCWS484824	24"	48" / 48"	1"	30	1	\$676	\$602
__TRCWS484830	30"	48" / 48"	1"	30	1	\$676	\$676
__TRCWS606024	24"	60" / 60"	1"	47	1	\$847	\$759
__TRCWS606030	30"	60" / 60"	1"	47	1	\$847	\$759

Note: When ordering, insert MM for Maverick Series or AR for Arroyo before model number.

Pre Drill Holes: Tops are pre-drill for post legs MMLEGTRB – MMLEGTRS.

Ganging Hardware: Is recommended when placing tops side by side.  Lead Time.

training tables

Bases for Training Table Tops

(Leg heights vary and cannot be combined)



Post Leg 2 3/8" diameter (Set of 4 legs) for Training Table Tops

Model#	Description	Color	Weight	Cube	Height	Price
MMLEGTRB	4 Posts w/ Leveler	Black	14	1	27 13/16"	\$578
MMLEGTRS	4 Posts w/ Leveler	Brushed Steel	14	1	27 13/16"	\$578
MMLEGTRBC	4 Posts w/ Locking Casters	Black	14	1	27 15/16"	\$578
MMLEGTRSC	4 Posts w/ Locking Casters	Brushed Steel	14	1	27 15/16"	\$578
MMCULEG__	1 Individual Post Leg		14	1	27 15/16"	\$147

For individual post legs, add \$147/each. Specify complete model #MMCULEG__ (e.g. MMCULEGTRB)
Individual post leg includes mounting screws.

Legs are shipped un-installed and require minor assembly with woodscrews for each leg.
Tops 72"W, 78"W & 84"W requires 5 post legs. Tops are pre-drilled for 4 post legs only.

LEAD TIME

Accessories and Upgrades

MMGANG3

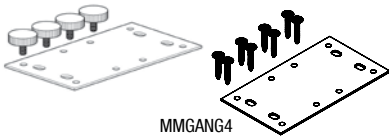

Ganging and Connecting Hardware (For use with factory-installed metal inserts)

Model#	Depth	Width	Height	Hardware	Weight	Cube	Price
MMGANG3	4"	6"	1/4"	Ganging	1	1	\$54
MMGANG4	4"	6"	1/4"	Connecting	1	1	\$54

MMGANG3: (1) Bracket & (4) Knobs. Recommended when placing tops side by side.

MMGANG4: (1) Bracket & (4) Bolts. Can be used for "L" shape & "U" shape connections.



Grommet

Model#	Depth	Width	Color	Surface Hole Diameter	Price
MMGR234B	3"	3"	Black Plastic	2 3/4"	\$73
MMGR234S	3"	3"	Silver Plastic	2 3/4"	\$73
MMGR234BCOVER			Grommet cover only, Black (Field Install)		\$37
MMGR234SCOVER			Grommet cover only, Silver (Field Install)		\$37

Specify grommet locations. Standard left, right or center, see below for standard location.

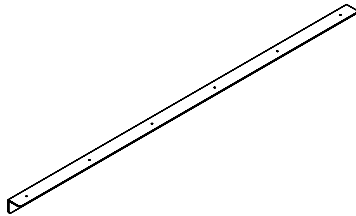

Stabilizer Bar, Black

Model#	Depth	Width	Height	Fits Top	Weight	Cube	Price
MMSB60	2"	44"	2"	60"W	6	1	\$155
MMSB66	2"	50"	2"	66"W	7	1	\$167
MMSB72	2"	56"	2"	72"W	8	1	\$181

May be purchased separately.

2 Stabilizer bars are included with 60"W, 66"W & 72"W tops, when purchased with top and post legs.
If using 84"W tops, one MMSB72 is required.

TRAINING TABLE TOP STANDARD GROMMET LOCATIONS (Unless otherwise specified)

Note: While sitting at unit, grommet locations are named from left to right. Line drawings shown below are standard locations.

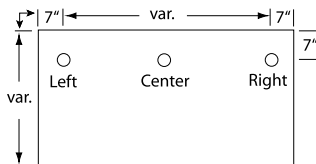

Rectangular
24" or 30"

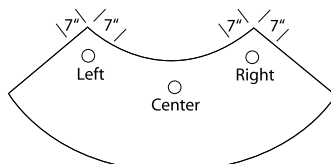

Curved
24" or 30"

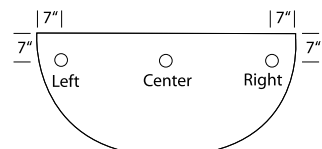

Half-Round
48" or 60"

maverick collection color options



Laminate finishes shown are approximations. Colors may vary between factories. TFM & HPL laminate finishes will vary.
 For sample requests, email Maverick West: orderentry@maverickdesk.com. Maverick East: mveorders@maverickdesk.com
Note: Renderings & line drawings shown are a resemblance to finished product. Product designs may vary. Discounts are different between factories.

The Fastest

DESK

ESTABLISHED 1992

IN THE WEST

MAVERICKDESK.COM

MAVERICK
OFFICE SOLUTIONS MADE IN THE U.S.A